



**IP44.DE**

**2023**

**BDK SA**

Route de la Riaz 64 | CH-1544 Gletterens  
Tél. +41 (0)26 667 92 66 | [info@bdk-luminaire.ch](mailto:info@bdk-luminaire.ch)

**[www.bdk-luminaire.ch](http://www.bdk-luminaire.ch)**

## product overview 2023

## solar

aqu	42
<b>N</b> cherry bubbls solar	48
fil	52
<b>N</b> lix spike solar	58
piek mini solar	64
<b>N</b> qua	68
<b>N</b> reed solar	74

## ceiling

lisc	202
pro R	204
pro S	208
slat + slat one	210
stic	214
up R	218
up S	220

## portable

<b>N</b> lix	82
glim	90
qu	96
aqu	108
<b>N</b> cherry bubbls	110
fil	116
<b>N</b> qua	118

## ground

como poller	224
cut poller	228
<b>N</b> dia poller	232
in A	238
in S	240
lin base	242
lin poller	246
lin spike	248
<b>N</b> lix spike solar	252
mir R poller	254
mir X poller	258
pad	262
piek	268
piek lettura	276
piek mini solar	280
pip poller	282
<b>N</b> reed solar	284
shot	286
slat poller	298
slat spike	302
stic	306
stic spike	310
jack	316
ground Zubehör	
accessory	320

## wall

como	122
como one	126
cut	128
cut control	132
cut one	134
dia	138
gap Q	144
gap X	148
gap Y	152
<b>N</b> gic	156
intro	164
lisc	168
pip	172
scap	176
scap one	180
slat	184
slat one	188
stic	192
stic control	196

## connect 322

<b>N</b> solar join	348
---------------------	-----



IP44.DE • 30 years • design • quality • innovation



Am Anfang stand eine schlichte Frage: Warum sind Leuchten für draußen eigentlich nicht mindestens so ästhetisch wie jene, die wir in Innenräumen schätzen? Mit dieser Frage haben wir vor genau 30 Jahren unsere allererste Außenleuchte entworfen. Seither sind Neuheiten bei IP44.DE nie immer nur Neuheiten, sondern immer auch ästhetische, funktionale oder technologische Weiterentwicklungen. Und auch in unserem Jubiläumsjahr warten wir wieder mit einigen interessanten Neuerungen auf. Eine steckt in der Umstellung unserer Leuchten auf 2700 Kelvin und damit einer Lichtfarbe, die fürs menschliche Auge ebenso angenehm ist wie für nachtaktive Insekten. Diesen großen und wichtigen Schritt haben wir abgeschlossen. Eine andere ist unsere wachsende Familie leistungsstarker Solarleuchten, mit denen wir vermehrt erneuerbare Energien ins Grüne bringen – ein Segment, das wir künftig noch kraftvoll ausbauen werden. Alle zusammen führen zu einer Frage, die uns vermutlich alle bewegt: Wann geht's endlich wieder raus?

It all began with a simple question: why aren't luminaires for outside use at least as aesthetically pleasing as those we have come to love indoors? This question led to the design of our very first outside luminaire, exactly 30 years ago. Since then, IP44.DE's new products have never just been new products, but also always embody an aesthetic, functional or technological development. And in this our anniversary year, we once again have a number of interesting innovations to present. One consists in changing our luminaires to 2700 Kelvin, a colour temperature that is just as pleasant for the human eye as it is to nocturnal insects. We have taken and completed this large, major step. Another is our growing family of powerful solar luminaires, that bring even more renewable energy into the green outdoors – a segment that we will be vigorously expanding in future. Altogether, this brings us to the question that most people are currently asking: when can we get outside again, at long last?

**Bernd Schmalhorst**  
 Gründer und Geschäftsführer IP44.DE  
 Founder and Managing Director IP44.DE

# journal 2023

product news

—→ 8

solar – powered by the sun

—→ 16

2700 Kelvin – bugfriendly

—→ 28

architectural colours

—→ 32

01

## reed solar

Ortsveränderliche  
Solarleuchte

movable  
solar luminaire

→ 74

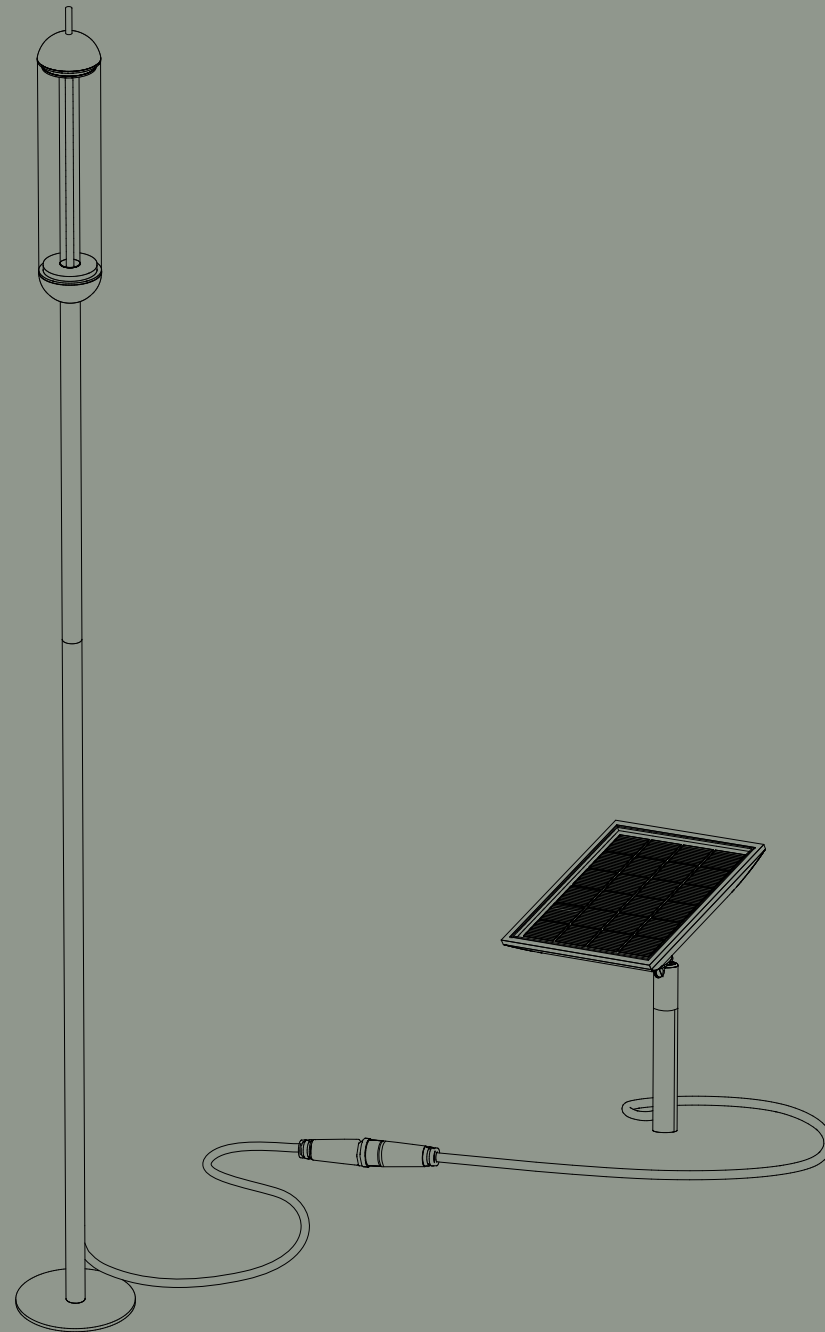

Unübersehbar inspiriert von der Natur. Auch überall dort zuhause, wo Schilf und Seen nicht in unmittelbarer Nähe sind. Die reed solar mit edlem rauchfarbenem Glaskörper und schlichtem Aluminiumstab setzt in zwei verschiedenen Höhen die Gartenplätze in Szene, die von der Sonne verwöhnt werden, aber ohne Stromanschluss sind.

Unmistakably inspired by nature. Also at home even in places where there are no reeds or lakes nearby. reed solar with its refined smoke-coloured glass body, simple aluminium pole and two different heights, creates the right setting for those parts of the garden that are blessed with sunshine but have no power connection.

02

## lix spike solar

Ortsveränderliche  
Solarleuchte

movable  
solar luminaire

→ 58

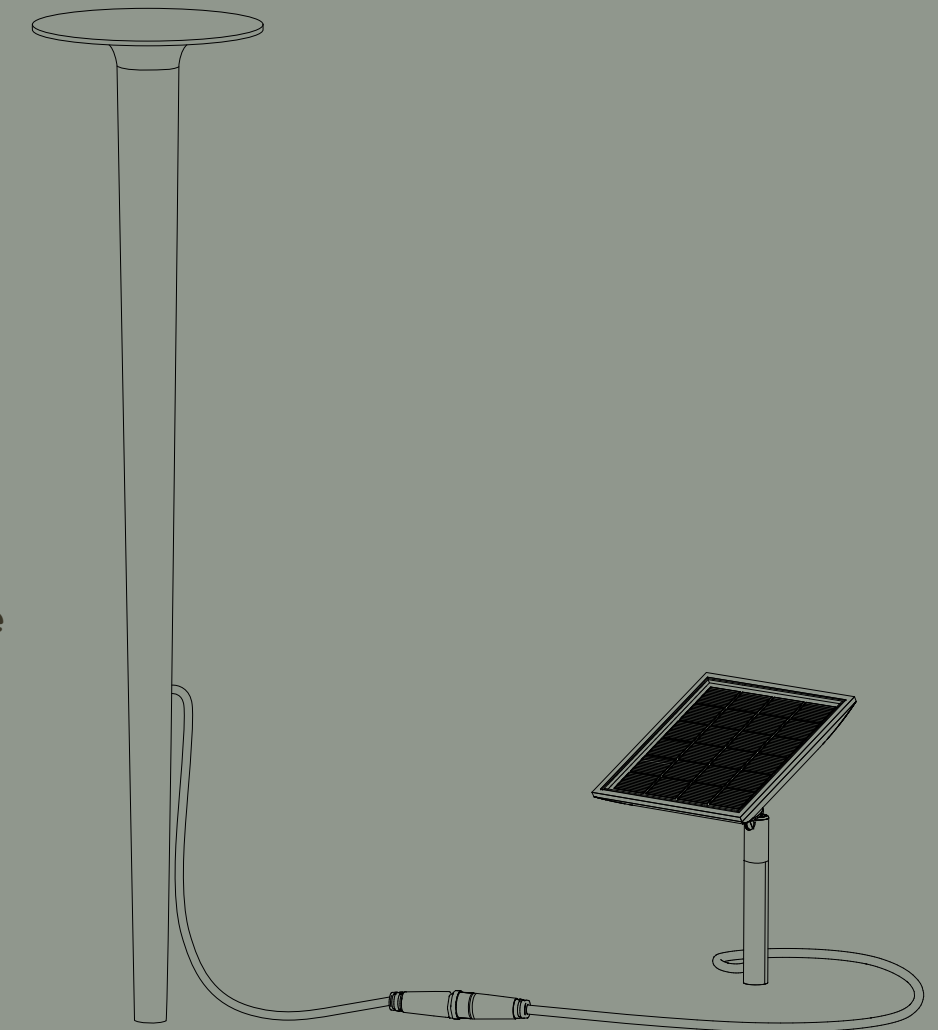

Die schlanke Schwester unseres portablen Bestsellers lix. Und genau wie diese ein Lieferant blendfreien, flächigen Rundumlichts, das atmosphärische Lichtinseln schafft. Die lix spike solar wird mit ihrem eigenen Solar- und Speichermodul versorgt und ist dadurch absolut autark.

The slender sister of our portable bestseller lix. And in just the same way, lix spike solar provides glare-free wide-area all-round light, creating atmospheric light islands. This luminaire is supplied with power by its own solar and storage module, so that it is absolutely self-sufficient.

# 03

## cherry bubbls

**Akku-Lichterkette**  
battery-powered  
light chain

→ 110

**Solar-Lichterkette**  
solar light chain

→ 48



Wenn künftig in immer mehr Gärten vermeintliche Glühwürmchen gesichtet werden, könnte das an cherry bubbls liegen. Die schlicht-edle Lichterkette lässt sich überall in Bäume hängen oder an Balkongeländern befestigen, wo feine Lichtpunkte dem Auge guttun. Und mit ihrer Powerbank oder dem Solarpanel als Energiequelle leuchtet sie allerorten fast so flexibel wie ein Glühwürmchen.

If glow worms are allegedly seen in lots more gardens in future, this could be due to cherry bubbls. The simple yet refined light chain can be hung anywhere from trees or fastened to balcony railings, wherever subtle light accents are pleasing to the eye. And the powerbank or solar panel as energy source makes it almost as flexible as a glow worm, shining all over the place.

# 04

## solar panel L

**Solarpanel**  
solar panel

→ 356

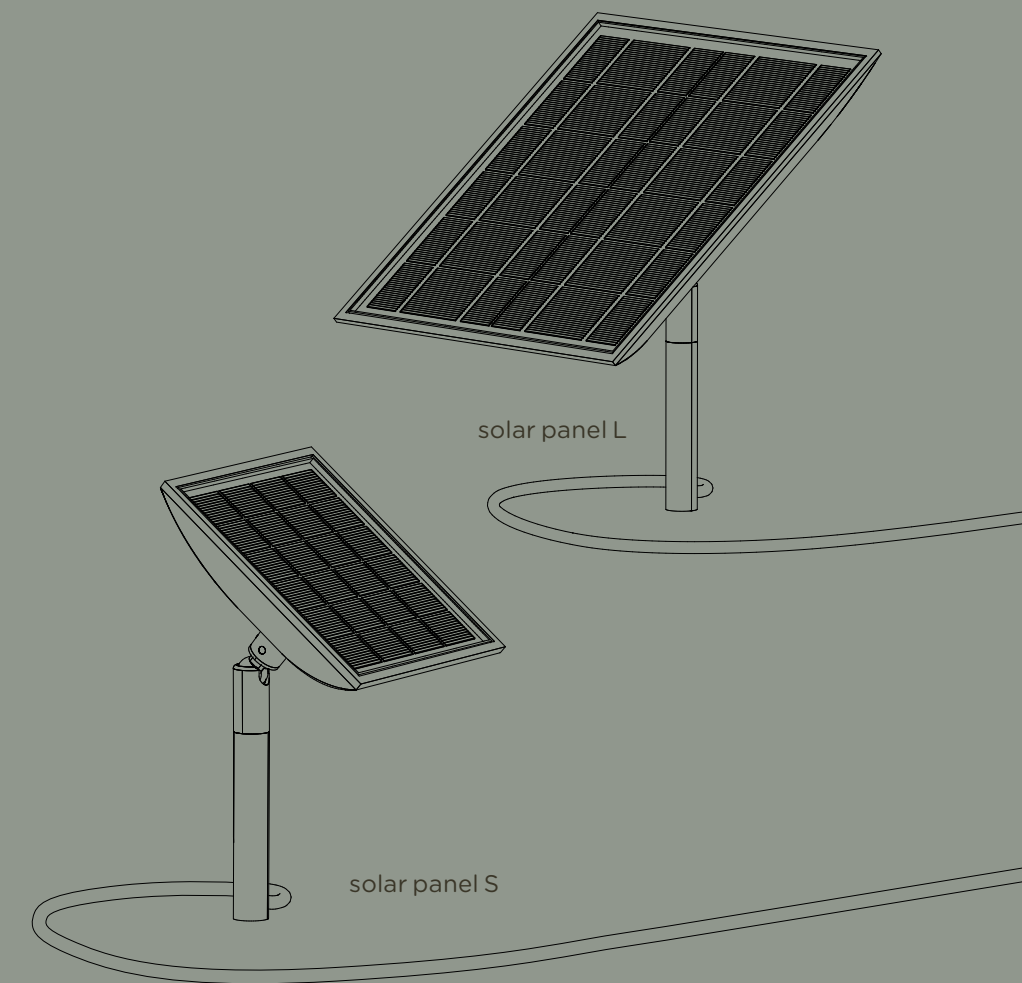

Mit unserem neuen System IP44.DE solar join lassen sich mehrere Solarleuchten zu einem autonomen Leuchtencluster verbinden. Den passenden Energieversorger dazu bildet unser solar panel L - dank drei Mal so großer Fläche wie jener des solar panel S leistungsstark für bis zu vier Leuchten.

Our new system IP44.DE solar join can be used to combine several solar luminaires into a self-sufficient luminaire cluster. The necessary energy supply comes from our solar panel L - which is three times as large as the solar panel S and provides enough power for up to four luminaires.

05

gic

Wandleuchte  
wall luminaire

→ 156



Eine Basis. Drei Oberflächen. Sieben ganz unterschiedliche Cover: gic bietet schier unzählige Gestaltungsmöglichkeiten. Ihr eleganter Korpus (zu haben in den Farben anthracite, pure white oder deep black) wird mit einer individuellen Akzentfläche ausgestattet, die jeder Leuchte einen persönlichen Ton verleiht.

One base. Three surfaces. Seven totally different covers: gic offers virtually countless creative possibilities. The elegant body (available in the colours anthracite, pure white or deep black) comes with an individual accent surface that gives every luminaire its own personal shade.

06

qua

Solar-Tischleuchte  
solar table luminaire

→ 68

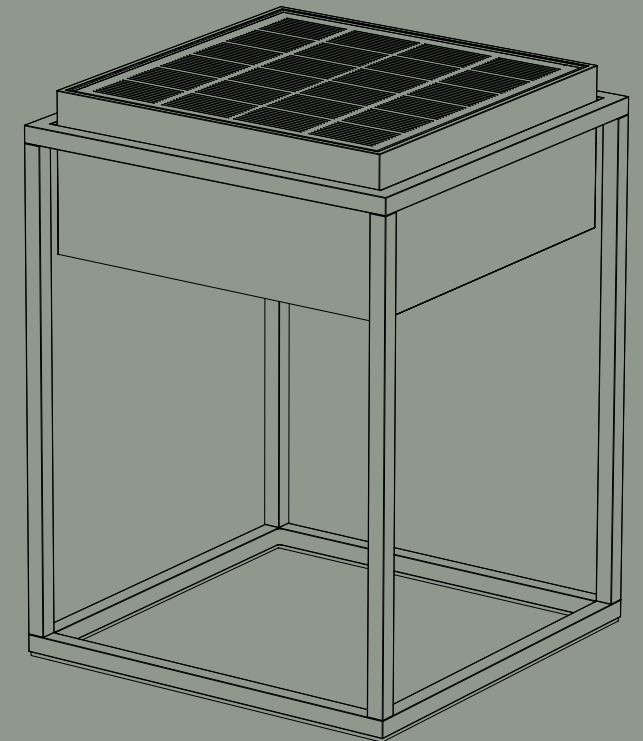

Klein, aber oho: qua ist der Powerwürfel unter den Solarleuchten. Punktet mit kompaktem Maß und eigener Stromversorgung. Durch den optionalen Wechsel vom Manuell- in den Automatik-Modus funktioniert die qua auch völlig autark.

Small, but what a luminaire! qua is the power cube among the solar luminaires. Scores with its compact size and own power supply. The optional changeover from manual to automatic mode makes qua practically self-sufficient.

07

lix

**Akku-Tischleuchte**  
battery-powered  
table luminaire

→ 82



Wo auch immer schönes Licht gewünscht wird: lix, die tragbare Akku-Tischleuchte für den Outdoor-Bereich. lix erzeugt per Dim to Amber verschiedene Lichtstimmungen von 2700K bis 1800K. Mit frozen silver, aubergine und midnight ist die lix jetzt in 10 ausdrucksstarken Farbtönen erhältlich!

Wherever beautiful light is wanted: lix, the portable battery table luminaire for outside use. With the dim to amber function, lix creates various different light moods from 2700K to 1800K. With frozen silver, aubergine and midnight the lix is now available in 10 expressive colour shades!

08

dia poller

**Pollerleuchte**  
bollard luminaire

→ 232

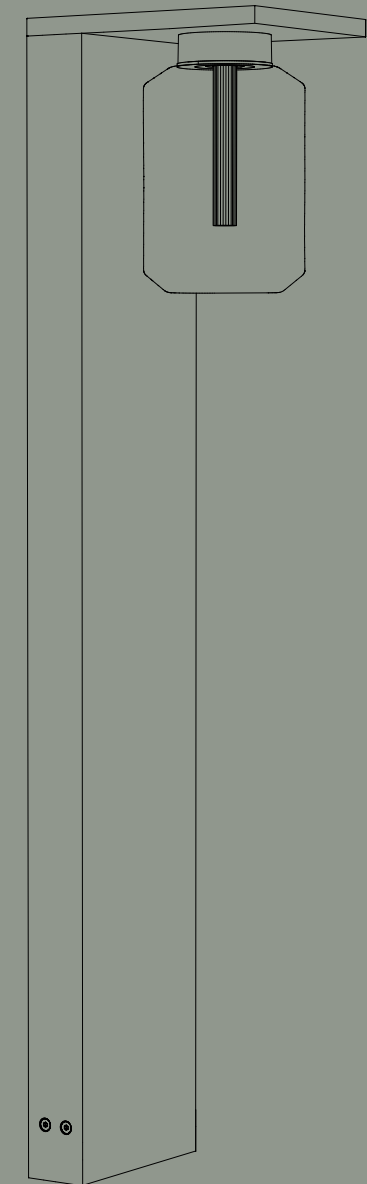

Wahrlich wegweisend: Unsere Reinterpretation einer klassischen Laterne steht auch als Pollerleuchte ihren Mann. An Auffahrt, Wegrand oder Parkplatz fällt ihre mehrfach designprämierte Kombination aus rauchfarbenem Glaskörper und profiliertem Acrylleuchtstab ins Auge.

Truly path-finding: our reinterpretation of a traditional lantern also stands its ground as a bollard luminaire. The eye-catching design that has won several awards combines a smoke-coloured glass body and profiled acrylic light rod, and is a creative feature when positioned at the drive, at the wayside or at the car park.



solar  
powered by the sun

## Sonne tanken. Einfach überall. Soaking up the sun. Simply everywhere.

Wir bei IP44.DE feiern die Sonnenwende! Mit einer Familie leistungsstarker Solarleuchten bringen wir erneuerbare Energie ins Grüne. Unsere sonnengepowerten Leuchten kommen ganz ohne Installation oder Stromnetz aus und lassen sich überall einsetzen, wo atmosphärisches Licht gefragt ist. Ein Balkon ohne Steckdose? Ein Solitärbaum, der einen Lichtspot vertragen könnte? Ein abgelegener Gartenplatz für gemütliche Abende? Unsere Solarleuchten spenden wunderbares atmosphärisches Licht, wo immer man es braucht und die Sonne scheint. In den sonnenreichen Monaten entfalten sie ihre Stärken daher eher als während der dunklen Jahreszeit.

Dass wir bei IP44.DE gerade jetzt auf klimaneutrale Energie setzen, ist übrigens alles andere als Zufall. Wir haben lange geforscht, bis wir Solarpaneele fanden, die uns technisch wirklich überzeugten. Auch die Akku-Ladefähigkeit hat sich in letzter Zeit noch einmal deutlich gesteigert. Ebenfalls verbessert hat sich die Qualität der elektronischen Komponenten, so dass heute auch geringere Wattagen bereits gutes Licht spenden.

Mit anderen Worten: die Zeit ist reif für Solarleuchten in IP44.DE-Qualität. Mit effizientem PV-Panel, starkem Akku und ebensolcher Lichtquelle spenden sie dauerhaft Freude. Und mit jedem Sonnenstrahl und jedem Sommer wieder aufs Neue.

Here at IP44.DE, we are celebrating the solstice! Our family of powerful solar luminaires brings renewable energy into the green outdoors. Our sun-powered luminaires manage without any installation or power grid and can be used wherever atmospheric light is wanted. A balcony without a power socket? A solitary tree that could do with a light spot? A remote spot in the garden for cosy evenings? Our solar luminaires provide atmospheric light wherever it is needed and the sun's shining. Their strengths are therefore on display more during the sunny months of the year rather than during the dark seasons.

By the way, it is not just a coincidence that we at IP44.DE are advocating climate-neutral energy right now. We have researched a long time to find solar panels that really convinced us from a technical point of view. Furthermore, recently there have also been clear further improvements in the charging capacity of batteries. The quality of electronic components has been similarly enhanced, so that even low wattages provide good light today.

In other words, the time is ripe for solar luminaires in IP44.DE quality. With an efficient PV panel, strong battery and also a strong light source, they generate pleasure in the long term, with every ray of sunshine, time and again every summer.

## cherry bubbls solar

Die schlicht-edle Lichterkette lässt sich überall in Bäume hängen oder an Balkongeländern befestigen, wo feine Lichtpunkte dem Auge guttun. Und mit ihrem Solarpanel als Energiequelle leuchtet sie allerorten völlig autark.

The simple yet refined light chain can be hung anywhere from trees or fastened to balcony railings, wherever subtle light accents are pleasing to the eye. And with its solar panel as energy source, it lights up everywhere completely self-sufficiently.

→ 48

## Powered by the sun.

Wenn die Sonne geht, schlägt ihre Stunde. Gleichzeitig tragen sie die Energie des Himmelskörpers in die Dämmerung, und das auf höchst flexible Art: reed solar, cherry bubbls solar, lix spike solar und piek mini solar lassen sich im Handumdrehen postieren, wo immer atmosphärisches Licht gebraucht wird. Dank separatem, kabelverbundenem Panel kann ihre Energieversorgung in Abstand zur Leuchte sonnenoptimiert ausgerichtet werden. fil, aqu und qua wiederum tragen als portable Leuchten ihre Energiequelle mit sich herum. Sie machen drinnen wie draußen eine ausgezeichnete Figur.

They come into their own when the sun goes down. At the same time, they bring the energy of the golden orb into the dusk in the most flexible fashion: reed solar, cherry bubbls solar, lix spike solar and piek mini solar can be positioned in next-to-no time, wherever atmospheric light is needed. Thanks to the separate wired panel, the energy supply can be aligned ideally to the sun at some distance from the luminaire. Then again, the portable luminaires fil, aqu and qua carry their energy source around with them. They look great inside or out.





## reed solar

**Unübersehbar inspiriert von der Natur. Auch überall dort zuhause, wo Schilf und Seen nicht in unmittelbarer Nähe sind.**

Unmistakably inspired by nature. Also at home even in places where there are no reeds or lakes nearby.

→ 74

## lix spike solar

**Die schlanke Schwester unseres portablen Bestsellers lix. Und genau wie diese ein Lieferant blendfreien Lichts.**

The slender sister of our portable bestseller lix. And supplies glare-free light in just the same way.

→ 58



## piek mini solar

**Setzt als dezenter Spot Pflanzen und Plätze in Szene. Und das dank separaten Solarpanels absolut autark.**

Discreet spot that creates the setting for plants and places. Absolutely self-sufficient thanks to the separate solar panel.

→ 64





## qua

**Klein, aber oho: qua ist der Powerwürfel unter den Solarleuchten. Punktet mit kompaktem Maß und eigener Stromversorgung.**

Small, but what a luminaire! qua is the power cube among the solar luminaires. Scores with its compact size and own power supply.

→ 68



## fil

**Als Bauhaus-inspirierte Leuchte auch in inaktivem Zustand ein wohnliches Accessoire. Dreistufig dimmbar und wahlweise mit manueller oder automatischer Schaltung.**

The luminaire inspired by Bauhaus is a homely accessory even when it is not in use. Can be dimmed in three steps and switched either manually or automatically.

→ 52

## aqu

**Glänzt in tragender Rolle: Mit ihrem sanft geschwungenen Griff lässt sich aqu überallhin tragen, wo echte Lichtblicke gefragt sind.**

Carries the day brilliantly: with its gently curved handle, aqu can be carried to wherever it is needed to create really bright spots.

→ 42



## IP44.DE solar join Sonne im System. Sun in the system.

Was strahlt heller als eine Solarleuchte? Ganz klar: mehrere von ihnen! Nützlich ist das zum Beispiel in Grundstücksabschnitten oder Gartenecken, in die man nicht extra eine Stromversorgung legen kann und dennoch größere Flächen ausleuchten will. Auch für die temporäre Beleuchtung eines Freisitzes oder einer Grillecke bietet sich die Kombination mehrerer IP44.DE-Leuchten an.

Mit unserem System IP44.DE solar join ist die leuchtende Gruppenbildung ganz einfach: lix spike solar, reed solar und piek mini solar lassen sich mittels Stecker verbinden und an ein Solarpanel anschließen. Auf diese Weise lassen sich bis zu vier Leuchten – auch unterschiedlicher Solarmodelle – verbinden.

Mehr zum Thema auf Seite 348.

What is brighter than a solar luminaire? That's obvious: several solar luminaires! This can be useful for example in sections of the grounds or corners of the garden where illumination is wanted for a larger area but without any intention of installing a power supply just for this purpose. Combining several IP44.DE luminaires is also ideal for temporary illumination of an outdoor seating area or a barbecue corner.

Our system IP44.DE solar join makes it easy to put luminaires into groups: lix spike solar, reed solar and piek mini solar can be linked with connectors and plugged into a solar panel. This makes it possible to connect up to four luminaires, also including different solar models.

More on this topic on page 348.



# solar facts

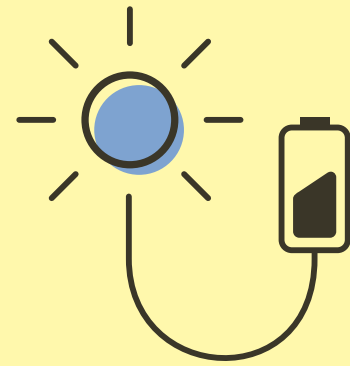

Zwei bis drei Sonnentage à 10 Stunden reichen aus, um den Akku vollständig mit klimaneutraler Energie über das Solarpanel zu laden.

Two to three days with 10 hours of sunshine are sufficient to recharge the battery fully with climate-neutral energy via the solar panel.

Ein komplett über das Solarpanel geladener Akku gibt Kraft für zahlreiche Abende stimmungsvoller Beleuchtung.

A battery completely charged via the solar panel has enough power for numerous evenings of atmospheric lighting.

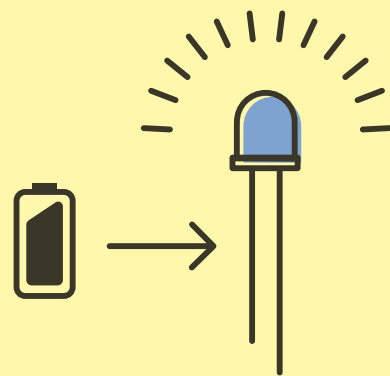

Bei Einbruch der Dunkelheit schaltet sich die Leuchte automatisch ein - und etwa fünf Stunden später selbsttätig wieder aus. qua und fil lassen sich zudem auch manuell schalten.

The luminaire switches on automatically when it starts to get dark - and switches off again of its own accord about five hours later. qua and fil can also be switched by hand.

reed solar, cherry bubbls solar, lix spike solar und piek mini solar sind über ein Kabel mit dem Solarpanel verbunden. Ihr Solarfeld lässt sich somit unabhängig von der Leuchte und in idealer Ausrichtung zur Sonne platzieren.

reed solar, cherry bubbls solar, lix spike solar and piek mini solar are connected with a lead to the solar panel. Their solar field can therefore be positioned anywhere regardless of the luminaire and in ideal alignment to the sun.

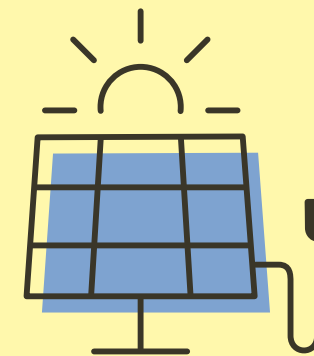

**Logisch: Je länger und stärker die Sonneneinstrahlung, umso größer ist auch die Leuchtdauer und optimale Performance. Bei Verschattung, falscher Ausrichtung, Verschmutzung, bewölktem Himmel oder niedrigstehender Sonne hingegen sinkt die Betriebsdauer spürbar.**

It's logical: the longer and stronger the sunshine, the greater the burn time and optimum performance. By contrast, operating hours are reduced noticeably in the shade, with incorrect alignment or soiling, when it is cloudy or when the sun is low in the sky.

Bis zum nächsten Recharging überbrückt der Akku problemlos auch drei Tage ohne Sonnenschein.

The battery can also easily bridge three days without sunshine before being recharged again.



# 2700 Kelvin bugfriendly



**Bestes Außenlicht.  
Für alle.**  
Best outside light.  
For everyone.

Gute Nachricht für alle, deren Leben sich draußen abspielt: Wir bei IP44.DE haben unsere Leuchten auf die Lichtfarbe 2700 Kelvin umgestellt. Unsere neue Standard-Lichtfarbe nimmt Rücksicht auf nachtaktive Insekten und sorgt dennoch für atmosphärisches Licht und beste Orientierung.

Good news for all those who love living outdoors: here at IP44.DE, we have converted our luminaires to the colour temperature of 2700 Kelvin. Our new standard colour temperature gives due consideration to nocturnal insects while still creating atmospheric light and offering guidance.

# Warum 2700 Kelvin? Why 2700 Kelvin?

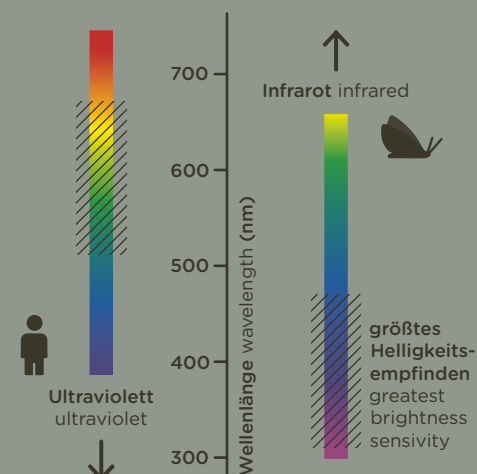
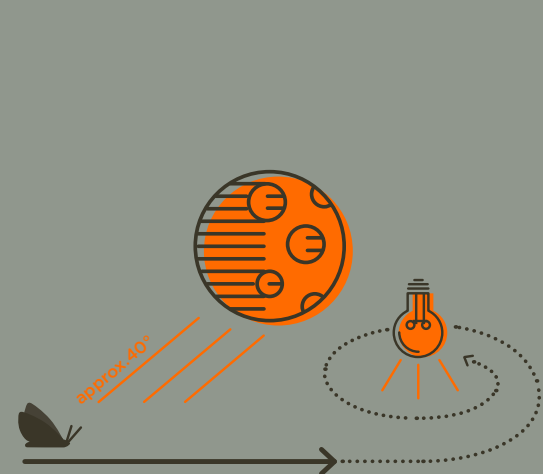

## 01 Flieg, Falter, flieg!

Licht ist nicht nur für uns Menschen, sondern auch viele Tierarten eine wichtige Orientierungshilfe. Falter, Motten und andere nachtaktive Insekten beispielsweise nutzen nachts das Mondlicht als Navigationshilfe. Ihren Kurs halten sie, indem sie in einem bestimmten Winkel zum Himmelskörper fliegen. Künstliche Lichtquellen können diese Orientierung stören, weil sie aufgrund der Nähe heller wirken und den Mond als Fixpunkt ablösen. Der Effekt lässt sich an manchen Straßenlaternen beobachten, die Insekten wie die Motten zum Licht locken.

## 01 Fly, butterfly, fly!

Light is important as a guide not only for us humans but also for many kinds of animals. For example, butterflies, moths and other nocturnal insects use moonlight to navigate at night. They can hold course by flying at a certain angle to the moon. Artificial light sources can interfere with this guidance, because their proximity makes them shine brighter and replace the moon as fixed point. The effect can be seen sometimes at street lights where insects like moths are drawn to the light.

## 02 Mit anderen Augen

Das gilt besonders für Leuchten mit einem hohen UV- oder Blauanteil. Denn nachtaktive Insekten reagieren auf ein ganz anderes Lichtspektrum als das menschliche Auge. Ihr größtes Helligkeitsempfinden liegt außerhalb des für den Menschen sichtbaren Lichtspektrums im kurzwelligen UV-, Blau- und Grünbereich, weshalb ihnen selbst mattes Mondlicht als Orientierung ausreicht. Warmweiße Leuchtdioden hingegen strahlen wenig bis gar kein UV-Licht ab.

## 02 With other eyes

This applies particularly to luminaires with a high UV or blue share, because nocturnal insects react to a completely different light spectrum than the human eye. Their greatest brightness sensitivity is outside the spectrum of light that is visible to people, and is in the short-wave UV, blue and green range, which is why even matt moonlight gives them sufficient guidance. On the other hand, warm white light diodes emit little UV light, if any.

## 03 Wärmstens empfohlen

Besonders warmweiße LEDs mit einem hohen Anteil an langwelligem roten Licht sind für die Orientierung von Kerbtieren weitgehend irrelevant. Das belegen unter anderem die Studien Mainzer Zoologen, die in Frankfurt/Main an Straßenleuchten mit unterschiedlichster Bestückung Insektenfallen postiert hatten: Rund um die Leuchten mit warmweißen LEDs fanden sich die wenigsten Insekten. Genau auf diese LEDs setzen wir und statten unsere Leuchten ab sofort konsequent mit insektenfreundlichen 2700 Kelvin aus.

## 03 Warmly recommended

Warm white LEDs in particular have a large share of long-wave red light and are largely irrelevant for the guidance of insects. This is verified among others in studies by zoologists from Mainz who positioned insect traps at a wide assortment of street lamps. The least insects were found around the street lamps with warm white LEDs. These are the same LEDs that we use. With immediate effect, our luminaires will be consistently fitted with insect-friendly 2700 Kelvin.

## 04 Sanfter Übergang

Die neue Standard-Lichtfarbe von 2700 Kelvin bei IP44.DE ist somit ein klares Plus für alle, die sich nicht nur eine ausgezeichnete, sondern auch eine umwelt- und insektenfreundliche Außenbeleuchtung wünschen. Weil ihre Farbtemperatur jener der meisten Innenleuchten ähnelt, sorgt sie außerdem für eine harmonischere Verbindung zwischen Innen- und Außenraumlicht.

## 04 Gentle transition

The new standard colour temperature of 2700 Kelvin at IP44.DE is therefore an added benefit for all those who want outside lighting that is not only excellent, but also kind to the environment and to insects. Furthermore, the colour temperature is similar to most indoor luminaires, thus creating a more harmonious changeover between inside and outside light.



# architectural colours

So vielfältig wie die Farben der Natur, so vielseitig ist auch die Architektur, die wir in sie setzen. Wir bei IP44.DE verwenden für unsere Außenleuchten hochwertige Pulverlacke, die zwischen Architektur und Umgebung organische Verbindungen wachsen lassen. Unsere wertigen Oberflächen werden unter aufwändiger Fertigungskontrolle zunächst durch Anodisation korrosionsbeständig und im Anschluss durch zweilagige Pulverbeschichtung farb- und witterungsbeständig. So können wir unserem Anspruch gerecht werden, unsere bewährte Qualität in einem breiten Farbspektrum mit edler Feinstruktur anzubieten.

The architecture that we use is as diverse as the colours of nature. Here at IP44.DE, we apply top quality powder coatings to our outside luminaires that let organic connections grow between the architecture and the surroundings. Subject to elaborate production controls, our quality surfaces are firstly anodised for corrosion resistance. Two-layer powder coating then makes them colourfast and weatherproof. And so we can live up to our claim of offering our proven quality in a broad colour range with a precious microstructure.



## anthracite

Liegt es an seiner dezenten Anmutung? Daran, dass es perfekt mit vielen Tür- und Fensterrahmen korrespondiert? Wir wissen es nicht. Wir wissen nur: anthracite RAL 7016 ist einer unserer beliebtesten Farbtöne. Is it because of its discreet appearance? Or because it is a perfect match with many door and window frames? We don't know. All we DO know is that anthracite RAL 7016 is one of our most popular colour shades.



## space grey

Architektonisch. Technisch. Kühl. Mit leichtem Eisenglimmer erinnert space grey an Bauelemente in DB-Farbtönen. Manche bezeichnen es auch als „Architektenfarbe“. Was nichts anderes als ein verstecktes Kompliment für einen Farbton ist, der Akzente zu setzen weiß, ohne sich zu wichtig zu nehmen. Architectural. Technical. Cool. space grey with its slight iron glimmer recalls structures in DB colour shades. Some call it the “architect’s colour”. Which is no more than a concealed compliment for a colour shade that sets accents without taking itself too seriously.



## cool brown

Ein leichter Glimmereffekt verleiht unserem Branton Struktur und zusätzliche Tiefe. Damit ist er perfekt für Holz- und Klinkerfassaden, die sich optisch mit ihrer Umgebung verbinden wollen. Dies gilt besonders, wenn das Umfeld grün, gewachsen, organisch ist. Überall dort wirkt unser Branton so, wie es sein Name bereits andeutet: ziemlich cool. A slight glimmer effect gives structure and additional depth to our shade of brown. It is simply perfect for timber and clinker brick facades seeking a visual link with their surroundings. This applies particularly when the setting consists of organic green vegetation, where our brown shade always comes across as the name indicates: rather cool.



## pure white

Weiß ist die Farbe der Reinheit und Freude. Als purster aller Farbtöne kommt pure white RAL 9016 vor allem dort zum Einsatz, wo Architektur sich auf das wirklich Wesentliche konzentriert. White is the colour of purity and joy. pure white RAL 9016, the purest of all colour shades is used primarily where architecture focuses on what really matters.



## deep black

Genau wie Weiß und Grau gehört Schwarz RAL 9005 zu den unbunten Farben. Man könnte auch sagen: Es hält sich vornehm zurück. deep black ist damit der perfekte Partner für klassische wie auch moderne Architektur. Like white and grey, black RAL 9005 is one of the achromatic colours. You could also describe it as being elegantly restrained. Which makes deep black the perfect partner for both classic and modern architecture.

solar  
portable  
wall  
ceiling  
ground  
connect  
solar join

solar

portable

wall

ceiling

ground

connect

solar join

# solar

	aqu	42
<i>NEW</i>	cherry bubbls solar	48
	fil	52
<i>NEW</i>	lix spike solar	58
	piek mini solar	64
<i>NEW</i>	qua	68
<i>NEW</i>	reed solar	74

aqu



solar

# aqu

Erfreulich, wenn eine Leuchte nicht nur ästhetisch, sondern auch noch höchst intelligent ist. Unsere Hybridleuchte aqu sammelt tagsüber die Energie, die sie abends in Form außergewöhnlich brillanten Lichts wieder abgibt. Ihr integriertes Solarpanel plus der leistungsstarke Akku spenden zahlreiche Stunden sympathische Helligkeit. Sollte die Kraft der Sonne nicht ausreichen, ist eine Ladung über einen seitlichen USB-Port möglich.

Isn't it wonderful when a luminaire is not just aesthetic but also highly intelligent? Our hybrid luminaire aqu collects energy during the day and emits it in the form of amazingly bright light in the evening. Its integrated solar panel and efficient battery provide many hours of warm and welcoming brightness. If enough power is not available from the sun, the luminaire can be recharged using the USB port on the side.



aqu



So schön, dass man sie gern mit ins Haus nehmen würde (und das kann man ja auch): Mit ihrem sanft geschwungenen Griff lässt sich aqu überall dorthin tragen, wo ein echter Lichtblick gefragt ist. So beautiful that you'll want to take it indoors too (and you can!): with its gently curved handle, aqu allows you to take it wherever you need to create a real bright spot.



**aqu** Design: Klaus Nolting

**Technische Daten:**  
LED  
NiMH-Akku  
3x 2400 mAh  
2700K  
Solarpanel

**Betriebsdauer:**  
· ca. 10 Std. auf Stufe 3  
· ca. 12 Std. auf Stufe 2  
· ca. 24 Std. auf Stufe 1

**3-Stufen-Dimmer**

**Alternative Stromversorgung:**  
1,2 m USB-C-Kabel inklusive

**Material:**  
mundgeblasenes Kristallglas  
Aluminiumguss  
pulverbeschichtet

**Schutzart:**  
IP65



**Lichtrichtung:**



**technical information:**  
LED  
NiMH battery  
3x 2400 mAh  
2700K  
solar panel

**battery operating time:**  
· approx. 10 hrs. at level 3  
· approx. 12 hrs. at level 2  
· approx. 24 hrs. at level 1

**3-step dimming**

**alternative power source:**  
1,2 m USB-C-cable included

**material:**  
mouth-blown crystal glass  
aluminium die-casting  
powder-coated

**protection class:**  
IP65



**light direction:**



aqu S	Farbe colour	Art.-Nr. item no.	Systemleistung system performance
	true gold	91910-TG	1,5 W/75 lm
	bright bronze	91910-BB	1,5 W/75 lm
	pearl white	91910-PW	1,5 W/75 lm
	jet black	91910-JB	1,5 W/75 lm
aqu M			
	true gold	91911-TG	1,5 W/75 lm
	bright bronze	91911-BB	1,5 W/75 lm
	pearl white	91911-PW	1,5 W/75 lm
	jet black	91911-JB	1,5 W/75 lm
<b>Zubehör accessory</b>	<b>Artikel article</b>	<b>Art.-Nr. item no.</b>	
	USB-Ladegerät USB-charger	55920	

Preise in separater Preisliste . prices in separate price list + [www.IP44.de](http://www.IP44.de)



cherry bubbis solar

NEW

solar

# cherry bubbls solar

Wenn künftig in immer mehr Gärten vermeintliche Glühwürmchen gesichtet werden, könnte das an cherry bubbls solar liegen. Die schlicht-edle Lichterkette lässt sich überall in Bäume hängen oder an Balkongeländern befestigen, wo feine Lichtpunkte dem Auge guttun. Und mit ihrem Solarpanel als Energiequelle leuchtet sie allerorten völlig autark.

If glow worms are allegedly seen in lots more gardens in future, this could be due to cherry bubbls solar. The simple yet refined light chain can be hung anywhere from trees or fastened to balcony railings, wherever subtle light accents are pleasing to the eye. And with its solar panel as energy source, it lights up everywhere completely self-sufficiently.



SOLAR



Die Lichterkette aktiviert sich bei Einbruch der Dunkelheit über die automatische Dämmerungsfunktion. The light chain switches on when it starts to get dark thanks to the automatic twilight function.



solar

## cherry bubbls solar Design: Klaus Nolting



**Technische Daten:**  
LED  
Lithium-Ionen Akku  
1x 2600 mAh  
2700K  
solar panel S  
7 Leuchtkörper

**Anschluss:**  
2 m Zuleitung Lichterkette  
(H05RN-F 2x0,75 mm<sup>2</sup>)  
+ 1 m Zuleitung Solarpanel  
(H05RN8-F 2x0,75 mm<sup>2</sup>)

zur Aufhängung

**Material:**  
Leuchte: Silikon  
+ rauchfarbenes Glas  
Solarpanel: Kopf: Aluminium-  
guss pulverbeschichtet;  
Stab: Edelstahl pulver-  
beschichtet; Klarglas

**Schutzart:**  
IP65



**Lichtrichtung:**



**technical information:**  
LED  
lithium-ion battery  
1x 2600 mAh  
2700K  
solar panel S  
7 luminaire bodies

**connection:**  
2 m supply cable light chain  
(H05RN-F 2x0,75 mm<sup>2</sup>)  
+ 1 m supply cable solar panel  
(H05RN8-F 2x0,75 mm<sup>2</sup>)

for hanging

**material:**  
luminaire: silicone  
+ smoke-coloured glass  
solar panel: head: aluminium-  
die-casting powder-coated;  
pole: stainless steel powder-  
coated; clear glass

**protection class:**  
IP65



**light direction:**



**Farbe**  
colour

black

**Art.-Nr.**  
item no.

93851

**Systemleistung**  
system performance

1,1 W/30 lm

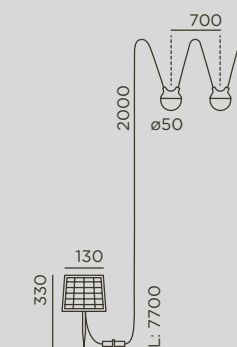

Größe in mm  
size in mm

+ cherry bubbls . Seite page 110

Preise in separater Preisliste . prices in separate price list + [www.IP44.de](http://www.IP44.de)

fil



solar

# fil

Der Würfel hat ja bekanntlich sechs Seiten: bei fil kombinieren sie ein bündig eingelassenes Solarpanel in Seiten aus transluzentem Stoff. Ein zweiter innenliegender Würfel aus transluzentem Polycarbonat sorgt für ein gleichmäßiges Lichtbild.

It's a well-known fact that a cube has six sides. In fil, the sides consist of a solar panel that is embedded flush in translucent fabric. A second inner cube of translucent polycarbonate creates a uniform light effect.



Wechsel zwischen Manuell- und Automatik-Modus über die integrierte Funktionstaste möglich. Im Automatik-Modus schaltet sich die Leuchte bei Dämmerung selbsttätig für 5 Stunden ein. Im Manuell-Modus erfolgt das Ein- und Ausschalten über die Funktionstaste. In beiden Modi ist die Leuchte in 3 Stufen dimmbar. The integrated function button allows you to change over between manual and automatic mode. In automatic mode, the luminaire lights up automatically when it starts to get dark and stays on for 5 hours. In manual mode, the function button is used for switching on and off. In both modes, the luminaire can be dimmed in 3 steps.



fil

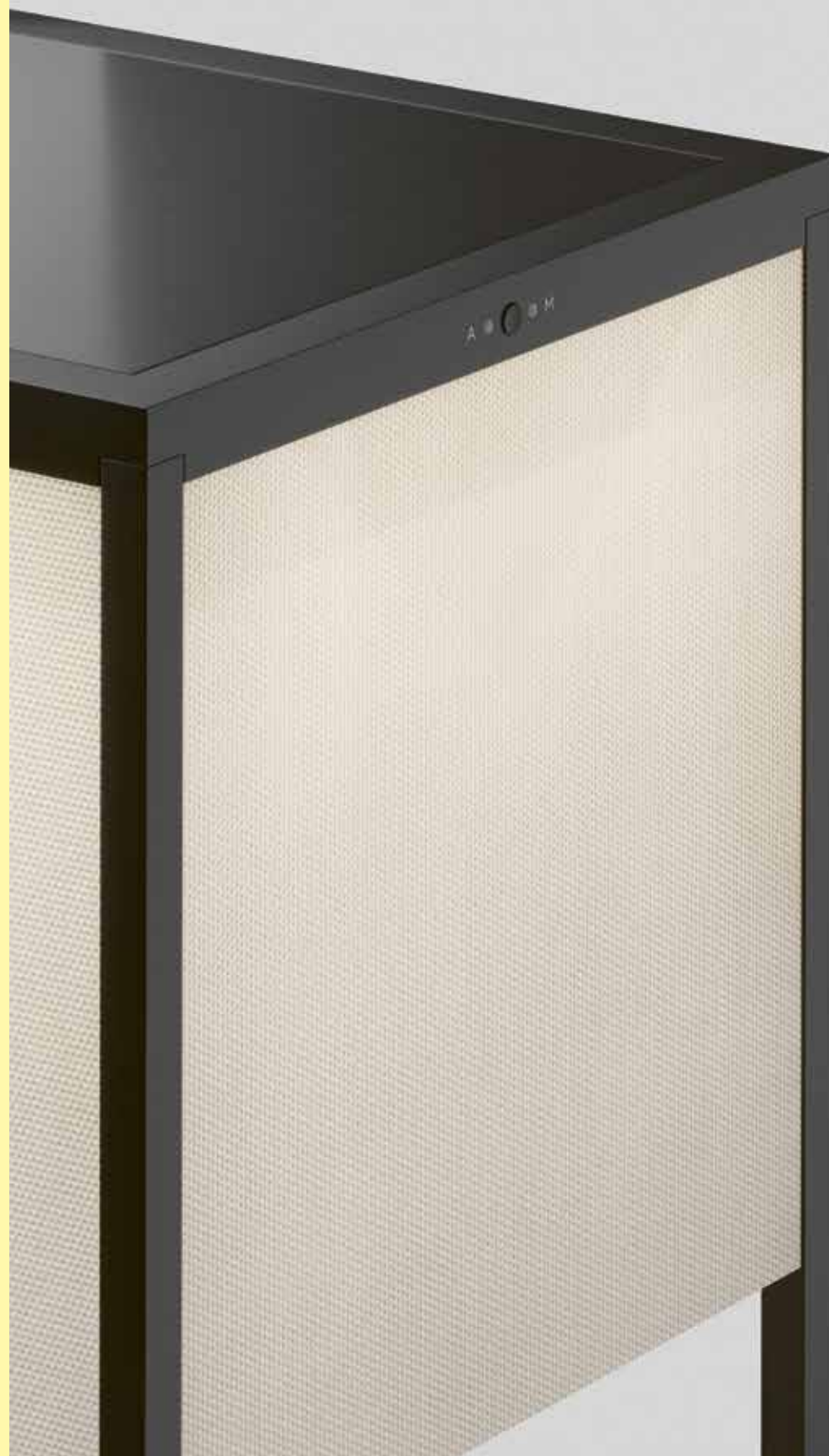

Das ist der Stoff, aus dem traumhaftes Licht ist: fil haben wir mit einem witterungs- und UV-beständigen Outdoor-Stoff bespannt, der Helligkeit auf die angenehmste Weise verbreitet. Zu haben ist unsere Bauhaus-inspirierte Leuchte wahlweise in 48 und 71 Zentimetern Höhe. This is the fabric that fabulous light is made of: fil is covered with weatherproof, UV-resistant outdoor fabric that emanates brightness in a very pleasant way. Our Bauhaus-inspired luminaire is available in a height of 48 and 71 centimetres.



**fil** Design: Klaus Nolting

<p><b>Technische Daten:</b> LED Lithium-Ionen Akku 4x 2600 mAh 2700K Solarpanel</p> <p><b>Optional Wechsel zwischen Manuell- + Automatik-Modus</b></p> <p><b>Betriebsdauer Automatik-Modus:</b> · automat. Einschaltung bei Dämmerung für ca. 5 Std.</p> <p><b>Betriebsdauer Manuell-Modus:</b> · ca. 5 Std. bei 100% (Stufe 3) · ca. 10 Std. bei 50% (Stufe 2) · ca. 20 Std. bei 25% (Stufe 1)</p> <p><b>3-Stufen-Dimmer</b></p>	<p><b>Material:</b> Aluminium pulverbeschichtet Abdeckung: weißer Outdoor-Stoff transluzent</p> <p><b>Schutzart:</b> IP65</p> <p><b>Lichtrichtung:</b></p> <p><b>Alternative Stromversorgung:</b> 2 m USB-C-Kabel inklusive</p>	<p>technical information: LED lithium-ion battery 4x 2600 mAh 2700K solar panel</p> <p>optional change between manual + automatic mode</p> <p>battery operating time automatic mode: · automat. switch-on at dusk for approx. 5 hrs.</p> <p>battery operating time manual mode: · approx. 5 hrs. at 100% (level 3) · approx. 10 hrs. at 50% (level 2) · approx. 20 hrs. at 25% (level 1)</p> <p>3-step dimming</p>	<p>material: aluminium powder-coated cover: white outdoor fabric translucent</p> <p>protection class: IP65</p> <p>light direction:</p> <p>alternative power source: 2 m USB-C-cable included</p>
---	---	--	--

<b>fil S</b>	<b>Farbe</b> colour	<b>Art.-Nr.</b> item no.	<b>Systemleistung</b> system performance
--------------	------------------------	-----------------------------	---

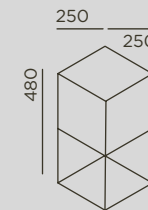

deep black  
RAL 9005

93810-BL

7 W/230 lm

<b>fil M</b>	<b>Farbe</b> colour	<b>Art.-Nr.</b> item no.	<b>Systemleistung</b> system performance
--------------	------------------------	-----------------------------	---

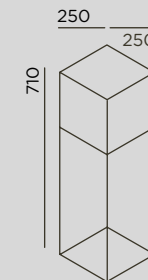

deep black  
RAL 9005

93811-BL

7 W/230 lm

Größe in mm  
size in mm

<b>Zubehör</b> accessory	<b>Artikel</b> article	<b>Art.-Nr.</b> item no.
-----------------------------	---------------------------	-----------------------------



USB-Ladegerät black  
USB-charger black

55920-BL

Preise in separater Preisliste . prices in separate price list + [www.IP44.de](http://www.IP44.de)

# lix spike solar

NEW

solar

# lix spike solar

Die schlanke Schwester unseres portablen Bestsellers lix. Und genau wie diese ein Lieferant blendfreien, flächigen Rundumlichts, das atmosphärische Lichtinseln schafft. Die lix spike solar wird mit ihrem eigenen Solar- und Speichermodul versorgt und ist dadurch absolut autark.

The slender sister of our portable bestseller lix. And in just the same way, lix spike solar provides glare-free wide-area all-round light, creating atmospheric light islands. This luminaire is supplied with power by its own solar and storage module, so that it is absolutely self-sufficient.

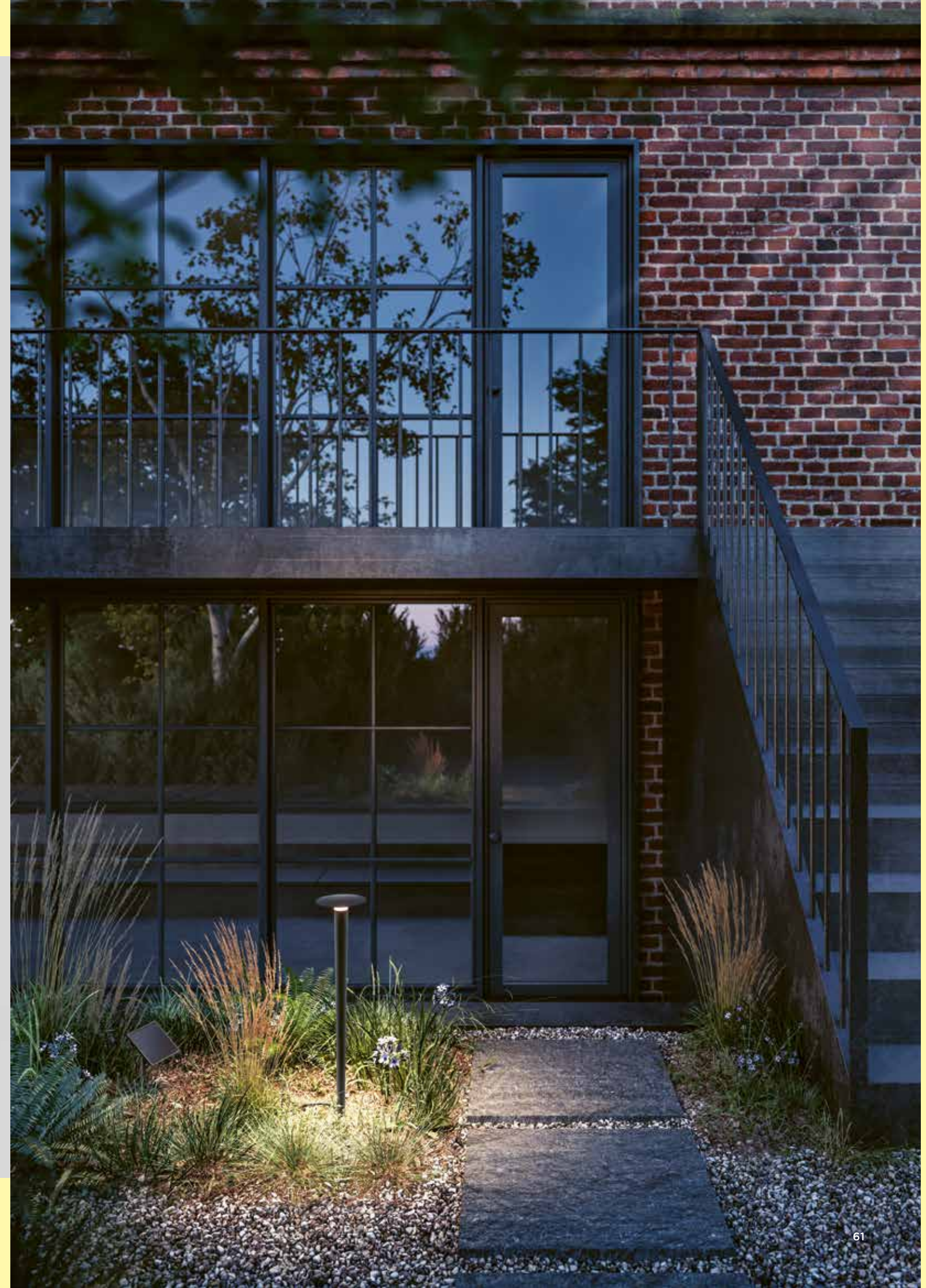

# lix spike solar



Die Leuchte aktiviert sich bei Einbruch der Dunkelheit über die automatische Dämmerungsfunktion. The luminaire switches on when it starts to get dark thanks to the automatic twilight function.

Die lix spike solar benötigt weder Stromanschluss noch festen Untergrund. Sehr autark also. Dank des Solarpanels ist sie ihr eigener Energieversorger! lix spike solar requires neither a power outlet nor a solid surface. That makes it very self-sufficient. The solar panel supplies all the energy it needs.



## lix spike solar Design: Klaus Nolting

für unbefestigte Beet- und Grünflächen for unpaved beds and greens

**Lichttechnik:**  
LED  
Lithium-Ionen Akku  
1x 2600 mAh  
2700K  
solar panel S

**Anschluss:**  
0,8 m Zuleitung Leuchte  
(H05RN8-F 2x0,75 mm<sup>2</sup>)  
+ 1 m Zuleitung Solarpanel  
(H05RN8-F 2x0,75 mm<sup>2</sup>)

ortsveränderlich

**Material:**  
Leuchte: Aluminiumguss pulverbeschichtet + Polycarbonat matt  
Solarpanel: Kopf: Aluminiumguss pulverbeschichtet; Stab: Edelstahl pulverbeschichtet; Klarglas

**Schutzart:**  
IP65



**Lichtrichtung:**



**light technology:**  
LED  
lithium-ion battery  
1x 2600 mAh  
2700K  
solar panel S

**connection:**  
0,8 m supply cable luminaire  
(H05RN8-F 2x0,75 mm<sup>2</sup>)  
+ 1 m supply cable solar panel  
(H05RN8-F 2x0,75 mm<sup>2</sup>)

movable

**material:**  
luminaire: aluminium die-casting powder-coated + polycarbonate matt  
solar panel: head: aluminium-die-casting powder-coated; pole: stainless steel powder-coated; clear glass



**protection class:**  
IP65

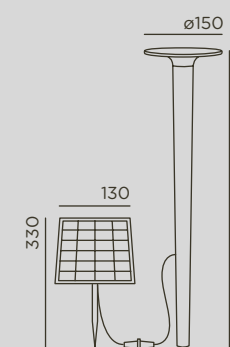

**light direction:**



Größe in mm  
size in mm

Farbe colour	Art.-Nr. item no.	Systemleistung system performance
 anthracite RAL 7016	93093-AN	1,1 W/65 lm
 cool brown	93093-CB	1,1 W/65 lm
 deep black RAL 9005	93093-BL	1,1 W/65 lm

+ Anschluss optional mit IP44.DE solar join . Produktdetails Seite 348  
connection with IP44.DE solar join as an option . product details page 348

+ lix . Seite page 82

Preise in separater Preisliste . prices in separate price list + [www.IP44.de](http://www.IP44.de)



piek mini solar



# piek mini solar

piek mini solar ist eine Insellösung im besten Sinne. Mit eigenem Solar- und Speichermodul lässt sich das flexible Up- oder Downlight nämlich überall dort einsetzen, wo Licht gewünscht, aber kein Stromanschluss in der Nähe ist. Autark ist auch ihre Funktion: Die Dämmerungsfunktion aktiviert piek mini solar selbsttätig für die Dauer von 5 Stunden, sobald es dunkelt.

piek mini solar is a stand-alone solution in the best sense of the word. The flexible up- or downlight has its own solar and storage module so it can be used in places where light is needed but where there is no power socket in the vicinity. It is also self-sufficient in terms of functionality: the twilight function activates piek mini solar automatically for 5 hours as soon as it starts to get dark.

Die Leuchte aktiviert sich bei Einbruch der Dunkelheit über die automatische Dämmerungsfunktion. The luminaire switches on when it starts to get dark thanks to the automatic twilight function.



## piek mini solar Design: Sebastian David Büscher

für unbefestigte Beet- und Grünflächen for unpaved beds and greens

**Lichttechnik:**  
LED  
Lithium-Ionen Akku  
1x 2600 mAh  
2700K  
solar panel S

**Reflektor:** Flood

**Anschluss:**  
1 m Zuleitung Leuchte (H05RN8-F 2x0,75 mm<sup>2</sup>)  
+ 1 m Zuleitung Solarpanel (H05RN8-F 2x0,75 mm<sup>2</sup>)

ortsveränderlich

**Material:**  
Leuchte: Kopf: Aluminiumguss pulverbeschichtet + Stab: Edelstahl pulverbeschichtet + Klarglas  
Solarpanel: Kopf: Aluminiumguss pulverbeschichtet; Stab: Edelstahl pulverbeschichtet; Klarglas

**Schutzart:**  
IP65

**Lichtstrahlung:**

**light technology:**  
LED  
lithium-ion battery  
1x 2600 mAh  
2700K  
solar panel S

**reflector:** flood

**connection:**  
1 m supply cable luminaire (H05RN8-F 2x0,75 mm<sup>2</sup>)  
+ 1 m supply cable solar panel (H05RN8-F 2x0,75 mm<sup>2</sup>)

movable

**material:**  
luminaire: head: aluminium die-casting powder-coated + pole: stainless steel powder-coated + clear glass  
solar panel: head: aluminium-die-casting powder-coated; pole: stainless steel powder-coated; clear glass

**protection class:**  
IP65

**light direction:**

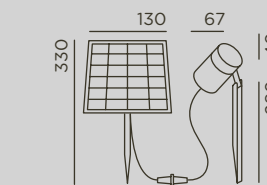

Größe in mm  
size in mm

Farbe colour	Art.-Nr. item no.	Systemleistung system performance
anthracite RAL 7016	93076-AN	1,1 W/70 lm
cool brown	93076-CB	1,1 W/70 lm
deep black RAL 9005	93076-BL	1,1 W/70 lm

+ Anschluss optional mit IP44.DE solar join . Produktdetails Seite 348  
connection with IP44.DE solar join as an option . product details page 348

+ piek . Seite page 268  
+ piek lettura . Seite page 276

Preise in separater Preisliste . prices in separate price list + [www.IP44.de](http://www.IP44.de)

qua

NEW



solar

# qua

Klein, aber oho: qua ist der Powerwürfel unter den Solarleuchten. Punktet mit kompaktem Maß und eigener Stromversorgung. Durch den optionalen Wechsel vom Manuell- in den Automatik-Modus funktioniert die qua auch völlig autark.

Small, but what a luminaire! qua is the power cube among the solar luminaires. Scores with its compact size and own power supply. The optional changeover from manual to automatic mode makes qua practically self-sufficient.



qua



Über die integrierte Funktionstaste ist ein Wechsel zwischen Manuell- und Automatik-Modus möglich. Im Automatik-Modus schaltet sich die Leuchte bei Dämmerung selbsttätig für 5 Stunden ein. Im Manuell-Modus erfolgt das Ein- und Ausschalten über die Funktionstaste. In beiden Modi ist die Leuchte in 3 Stufen dimmbar. The integrated function button can be used to change over between manual and automatic mode. In automatic mode, the luminaire lights up automatically when it starts to get dark and stays on for 5 hours. In manual mode, the function button is used for switching on and off. In both modes, the luminaire can be dimmed in 3 steps.

**qua** Design: Klaus Nolting



**Technische Daten:**  
LED  
Lithium-Ionen Akku  
2x 2000 mAh  
2700K  
Solarpanel

**Optional Wechsel zwischen Manuell- + Automatik-Modus**

**Betriebsdauer Automatik-Modus:**  
· automat. Einschaltung bei Dämmerung für ca. 5 Std.

**Betriebsdauer Manuell-Modus:**  
· ca. 7 Std. bei 100% (Stufe 3)  
· ca. 14 Std. bei 50% (Stufe 2)  
· ca. 32 Std. bei 25% (Stufe 1)

**3-Stufen-Dimmer**

**Material:**  
Aluminiumguss  
lackiert  
Polycarbonat matt

**Schutzart:**  
IP65



**Lichtrichtung:**



**Alternative Stromversorgung:**  
2 m USB-C-Kabel inklusive

**technical information:**  
LED  
lithium-ion battery  
2x 2000 mAh  
2700K  
solar panel

**optional change between manual + automatic mode**

**battery operating time automatic mode:**  
· automat. switch-on at dusk for approx. 5 hrs.

**battery operating time manual mode:**  
· approx. 7 hrs. at 100% (level 3)  
· approx. 14 hrs. at 50% (level 2)  
· approx. 32 hrs. at 25% (level 1)

**3-step dimming**

**material:**  
aluminium die-casting  
lacquered  
polycarbonate matt

**protection class:**  
IP65



**light direction:**



**alternative power source:**  
2 m USB-C-cable included

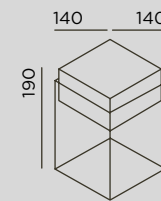

Größe in mm  
size in mm

Farbe colour	Art.-Nr. item no.	Systemleistung system performance
bright bronze	93825-BB	2,1 W/75 lm
pearl white	93825-PW	2,1 W/75 lm
jet black	93825-JB	2,1 W/75 lm

Zubehör accessory	Artikel article	Art.-Nr. item no.
	USB-Ladegerät black USB-charger black	55920-BL

Preise in separater Preisliste . prices in separate price list + [www.IP44.de](http://www.IP44.de)

reed solar

NEW



solar

# reed solar

Unübersehbar inspiriert von der Natur. Auch überall dort zuhause, wo Schilf und Seen nicht in unmittelbarer Nähe sind. Die reed solar mit edlem rauchfarbenem Glaskörper und schlichtem Aluminiumstab setzt in zwei verschiedenen Höhen die Gartenplätze in Szene, die von der Sonne verwöhnt werden, aber ohne Stromanschluss sind.

Unmistakably inspired by nature. Also at home even in places where there are no reeds or lakes nearby. reed solar with its refined smoke-coloured glass body, simple aluminium pole and two different heights, creates the right setting for those parts of the garden that are blessed with sunshine but have no power connection.



# reed solar

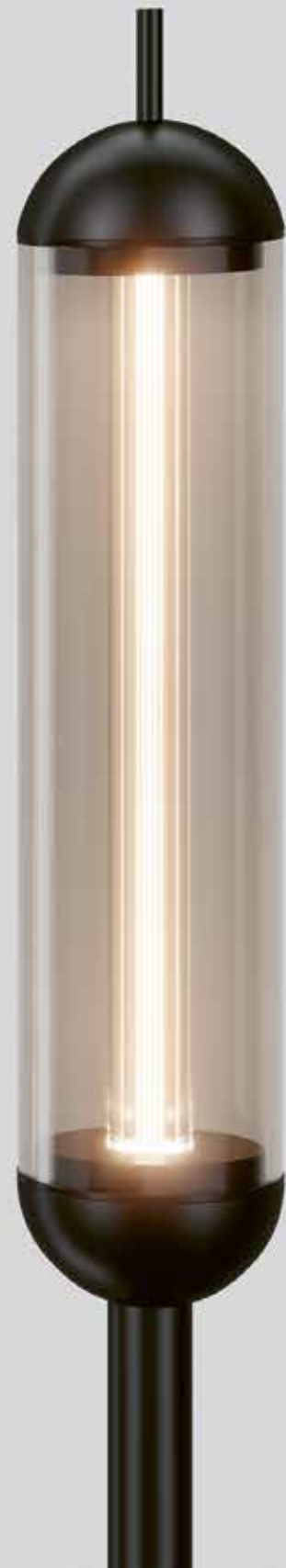

Kein Strom in der Nähe? Mit eigenem Solar- und Speichermodul bringt die reed solar trotzdem Licht ins Dunkel! Die Leuchte aktiviert sich bei Einbruch der Dunkelheit über die automatische Dämmerungsfunktion. No electricity nearby? reed solar comes with its own solar and storage module so it still brings light into the darkness! The luminaire switches on when it starts to get dark thanks to the automatic twilight function.



## reed solar Design: Sebastian David Büscher

für unbefestigte Beet- und Grünflächen for unpaved beds and greens

<b>Lichttechnik:</b> LED Lithium-Ionen Akku 1x 2600 mAh 2700K solar panel S  <b>Anschluss:</b> 1,4 m (reed M)/1,2 m (reed L) Zuleitung Leuchte (H05RN8-F 2x0,75 mm <sup>2</sup> ) + 1 m Zuleitung Solarpanel (H05RN8-F 2x0,75 mm <sup>2</sup> )  ortsveränderlich	<b>Material:</b> Leuchte: Aluminiumguss pulverbeschichtet + rauchfarbenes Glas Solarpanel: Kopf: Aluminiumguss pulverbeschichtet; Stab: Edelstahl pulverbeschichtet; Klarglas  <b>Schutzart:</b> IP65  A E	<b>light technology:</b> LED lithium-ion battery 1x 2600 mAh 2700K solar panel S  <b>connection:</b> 1,4 m (reed M)/1,2 m (reed L) supply cable luminaire (H05RN8-F 2x0,75 mm <sup>2</sup> ) + 1 m supply cable solar panel (H05RN8-F 2x0,75 mm <sup>2</sup> )  movable	<b>material:</b> luminaire: aluminium die-casting powder-coated + smoke-coloured glass solar panel: head: aluminium-die-casting powder-coated; pole: stainless steel powder-coated; clear glass  <b>protection class:</b> IP65  A E
	<b>Lichtrichtung:</b> 		<b>light direction:</b> 

reed M solar	Farbe colour	Art.-Nr. item no.	Systemleistung system performance
	deep black RAL 9005	93821-BL	1,1 W/22 lm

	deep black RAL 9005	93822-BL	1,1 W/22 lm
--	------------------------	----------	-------------

Größe in mm  
size in mm

+ Anschluss optional mit IP44.DE solar join . Produktdetails Seite 348  
connection with IP44.DE solar join as an option . product details page 348

Preise in separater Preisliste . prices in separate price list + [www.IP44.de](http://www.IP44.de)



# portable

<i>NEW</i>	lix	82
	glim	90
	qu	96
	aqu	108
<i>NEW</i>	cherry bubbls	110
	fil	116
<i>NEW</i>	qua	118



lix

Schwer zu sagen, was uns bei lix mehr begeistert: Ihre pur-schöne Form? Ihr ausdauernder Akku, der uns viele Stunden Helligkeit schenkt? Oder ihr angenehm blendfreies Licht, das sich ganz einfach per Dim to Amber von 2700K bis 1800K regulieren lässt? Wir wissen nur: lix ist genau das leuchtende Beispiel, das uns draußen gefehlt hat.

It's hard to say what we love most about lix: Its simple yet stunning form? Its long-lasting battery that treats us to many hours of brightness? Or is it its pleasant glare-free light, which can be easily controlled via dim to amber from 2700K to 1800K? One thing's for sure: lix is precisely the shining example of what's been missing in our outdoor setting.



reddot winner 2020  
lighting design

DESIGN PLUS



NEW

DIM TO  
AMBER   
2700K 1800K

Für noch mehr Atmosphäre: jetzt mit Dim to Amber von 2700K bis 1800K. For even more atmosphere: now with dim to amber from 2700K to 1800K.

lix



lix in weiteren neuen  
Farbtönen: aubergine .  
frozen silver . midnight.  
lix in further new colour  
shades: aubergine .  
frozen silver . midnight.



lix macht nicht nur bei Dunkelheit eine ausgezeichnete Figur – sie ist auch bei Tageslicht ein formschöner Hingucker. lix not only looks stunning in the dark but is also an attractive highlight during the day.

lix

lix Design: Klaus Nolting



<p><b>Technische Daten:</b> LED Lithium-Ionen Akku 2x 2600 mAh Dim to Amber 2700K - 1800K</p> <p><b>Betriebsdauer:</b> - je nach Dimmstufe 5 Std. bis 48 Std.</p> <p><b>Stromversorgung:</b> 1,2 m USB-C-Kabel inklusive</p>	<p><b>Material:</b> Aluminiumguss lackiert Polycarbonat matt</p> <p><b>Schutzart:</b> IP44</p> <p><b>Lichtrichtung:</b></p>	<p><b>technical information:</b> LED lithium-ion battery 2x 2600 mAh dim to amber 2700K - 1800K</p> <p><b>battery operating time:</b> - 5 hrs. to 48 hrs., depending on the dimming level</p> <p><b>power source:</b> 1,2m USB-C-cable included</p>	<p><b>material:</b> aluminium die-casting lacquered polycarbonate matt</p> <p><b>protection class:</b> IP44</p> <p><b>light direction:</b></p>
--	---	---	--



Farbe colour	Art.-Nr. item no.	Systemleistung system performance
true gold	93930-TG	4,2 W/200 lm
bright bronze	93930-BB	4,2 W/200 lm
pearl white	93930-PW	4,2 W/200 lm
jet black	93930-JB	4,2 W/200 lm
frozen silver	93930-FS	4,2 W/200 lm
aubergine	93930-AU	4,2 W/200 lm
midnight	93930-MN	4,2 W/200 lm
ruby	93930-RU	4,2 W/200 lm
sage	93930-SE	4,2 W/200 lm
sun	93930-SU	4,2 W/200 lm

Größe in mm  
size in mm

+ Mindestabnahmemenge: 4 Stück minimum order quantity: 4 pcs

Zubehör accessory	Artikel article	Art.-Nr. item no.
	USB-Ladegerät USB-charger	55920

+ lix spike solar . Seite page 58

Preise in separater Preisliste . prices in separate price list + [www.IP44.de](http://www.IP44.de)

glim



portable

# glim

Pure Eleganz, die mit ihrer reduzierten Formensprache Gemütlichkeit im Außenbereich erzeugt: glim! Die Akku-Tischleuchte lässt sich allorts positionieren. Der magnetische Leuchtenstab – unübersehbar vom klassischen Kerzenlicht inspiriert – funktioniert aber auch losgelöst vom Fuß, indem er ganz einfach auf metallische Oberflächen gesetzt wird.

Pure elegance in a reduced design language for cosy outdoor life: glim! The battery-powered table luminaire can be positioned everywhere. The magnetic luminaire pole – unmistakably inspired by traditional candlelight – also works when separated from the base: it can be placed quite simply on metallic surfaces.



portable



Für brillantes Licht und atmosphärische Lichtverteilung ist im Acrylkopf ein kleiner Reflektor eingearbeitet. Brilliant light and atmospheric light distribution is produced by a small reflector incorporated in the acrylic head.



**glim** Design: Klaus Nolting

**Technische Daten:**  
LED  
NiMH-Akku  
3x 1000 mAh  
2700K

**Betriebsdauer:**  
· ca. 7 Std. bei 100% (Stufe 3)  
· ca. 14 Std. bei 50% (Stufe 2)  
· ca. 28 Std. bei 25% (Stufe 1)

**3-Stufen-Dimmer**

**Stromversorgung:**  
1,2 m USB-C-Kabel inklusive

**Material:**  
Aluminiumguss lackiert  
Acrylglas

**Schutzart:**  
IP44



**Lichtrichtung:**



**technical information:**  
LED  
NiMH battery  
3x 1000 mAh  
2700K

**battery operating time:**  
· approx. 7 hrs. at 100% (level 3)  
· approx. 14 hrs. at 50% (level 2)  
· approx. 28 hrs. at 25% (level 1)

**3-step dimming**

**power source:**  
1,2 m USB-C-cable included

**material:**  
aluminium die-casting lacquered  
acrylic glass

**protection class:**  
IP44



**light direction:**

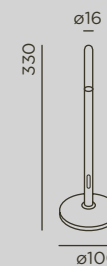

Größe in mm  
size in mm

Farbe colour	Art.-Nr. item no.	Systemleistung system performance
true gold	93910-TG	0,5 W/15 lm
bright bronze	93910-BB	0,5 W/15 lm
pearl white	93910-PW	0,5 W/15 lm
jet black	93910-JB	0,5 W/15 lm

+ Mindestabnahmemenge: 4 Stück minimum order quantity: 4 pcs

Zubehör accessory	Artikel article	Art.-Nr. item no.
	USB-Ladegerät black USB-charger black	55920-BL

Preise in separater Preisliste . prices in separate price list + [www.IP44.de](http://www.IP44.de)



qu



portable

qu

Die moderne Laterne mit großartigem Licht lässt sich überall mit hinnehmen, wo wir gerne sind! Kombiniert mit dem hook lässt die qu jede Wand erstrahlen, lässt sich am rope in Bäume, unter Veranda- oder Balkondecken hängen, oder zur Bodenmontage auf den pin hängen.

The modern lantern with great light can go wherever we want to be! In combination with the hook, qu shines a light on every wall, or you can hang it from the rope in trees, under veranda or balcony roofs, or from the pin set in the ground.



Durch den 3-fach Touch-Dimmer erzeugt sie stimmungsvolle Momente im Innen und Außen und fügt sich in den Ausführungen jet black + bright bronze mit amberfarbenem Glaskörper aufs Schönste in jedes Ambiente ein. With the 3-step touch dimmer, it creates atmospheric moments indoors and outdoors, while the colours jet black + bright bronze with the amber-coloured glass body harmonize beautifully with every setting.

qu



qu pin: Ihr schlichter Aluminiumstab wird einfach in den Boden gesteckt, qu über seinen auskragenden Arm gehängt - schon erstrahlt eine Insel wohlig-gemütlichen Lichts. qu pin: with the simple aluminium spike in the ground, qu hangs on the projecting arm, creating an island of homely-cosy light.

qu



Mit dem ausgeklappten Bügel lässt sich die qu auf den qu hook hängen und wird somit zur autarken Wandleuchte. With the hinged handle the qu can be hung on the qu hook and thus becomes an independant wall luminaire.

qu



portable

qu



qu Design: Sebastian David Büscher



**Technische Daten:**  
LED  
Lithium-Ionen Akku  
2x 2000 mAh  
2700K

**Betriebsdauer:**  
· ca. 5 Std. bei 100% (Stufe 3)  
· ca. 10 Std. bei 50% (Stufe 2)  
· ca. 20 Std. bei 25% (Stufe 1)

**3-Stufen-Touch-Dimmer**

**Stromversorgung:**  
1,2 m USB-C-Kabel inklusive

**Material:**  
Aluminiumguss lackiert  
amberfarbenes Glas

**Schutzart:**  
IP44



**Lichtrichtung:**



**technical information:**  
LED  
lithium-ion battery  
2x 2000 mAh  
2700K

**battery operating time:**  
· approx. 5 hrs. at 100% (level 3)  
· approx. 10 hrs. at 50% (level 2)  
· approx. 20 hrs. at 25% (level 1)

**3-step touch dimmer**

**power source:**  
1,2 m USB-C-cable included

**material:**  
aluminium die-casting lacquered  
amber-coloured glass

**protection class:**  
IP44



**light direction:**

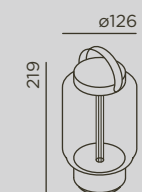

**Farbe**  
colour

bright bronze

jet black

**Art.-Nr.**  
item no.

93950-BB

93950-JB

**Systemleistung**  
system performance

3,5 W/76 lm

3,5 W/76 lm

+ Mindestabnahmemenge: 2 Stück minimum order quantity: 2 pcs

**Zubehör**  
accessory



**Artikel**  
article

USB-Ladegerät black  
USB-charger black

**Art.-Nr.**  
item no.

55920-BL

## Zubehör accessory

zur Aufhängung for hanging

qu rope

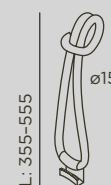

**Farbe**  
colour

black

**Art.-Nr.**  
item no.

93951

**Material**  
material

Silikon-Kautschuk +  
Polycarbonat lackiert  
silicone-rubber +  
polycarbonate lacquered

für Wandmontage for wall mounting

qu hook

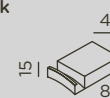

bright bronze

93952-BB

Aluminiumguss lackiert  
aluminium die-casting lacquered

jet black

93952-JB

Aluminiumguss lackiert  
aluminium die-casting lacquered

für unbefestigte Beet- und Grünflächen for unpaved beds and greens

qu pin

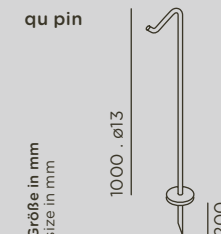

black

93953

Aluminiumguss  
pulverbeschichtet  
aluminium die-casting  
powder-coated

Preise in separater Preisliste . prices in separate price list + [www.IP44.de](http://www.IP44.de)

# aqu

Erfreulich, wenn eine Leuchte nicht nur ästhetisch, sondern auch noch höchst intelligent ist. Unsere Hybridleuchte aqu sammelt tagsüber die Energie, die sie abends in Form außergewöhnlich brillanten Lichts wieder abgibt. Ihr integriertes Solarpanel plus der leistungsstarke Akku spenden zahlreiche Stunden sympathische Helligkeit. Sollte die Kraft der Sonne nicht ausreichen, ist eine Ladung über einen seitlichen USB-Port möglich.

Isn't it wonderful when a luminaire is not just aesthetic but also highly intelligent? Our hybrid luminaire aqu collects energy during the day and emits it in the form of amazingly bright light in the evening. Its integrated solar panel and efficient battery provide many hours of warm and welcoming brightness. If enough power is not available from the sun, the luminaire can be recharged using the USB port on the side.

SOLAR



So schön, dass man sie gern mit ins Haus nehmen würde (und das kann man ja auch): Mit ihrem sanft geschwungenen Griff lässt sich aqu überall dorthin tragen, wo ein echter Lichtblick gefragt ist. So beautiful that you'll want to take it indoors too (and you can!): with its gently curved handle, aqu allows you to take it wherever you need to create a real bright spot.



## aqu Design: Klaus Nolting

### Technische Daten:

LED  
NiMH-Akku  
3x 2400 mAh  
2700K  
Solarpanel

### Betriebsdauer:

· ca. 10 Std. auf Stufe 3  
· ca. 12 Std. auf Stufe 2  
· ca. 24 Std. auf Stufe 1

### 3-Stufen-Dimmer

Alternative Stromversorgung:  
1,2 m USB-C-Kabel inklusive

Material:  
mundgeblasenes Kristallglas  
Aluminiumguss  
pulverbeschichtet

Schutzart:  
IP65



### Lichtrichtung:



technical information:  
LED  
NiMH battery  
3x 2400 mAh  
2700K  
solar panel

battery operating time:  
· approx. 10 hrs. at level 3  
· approx. 12 hrs. at level 2  
· approx. 24 hrs. at level 1

### 3-step dimming

alternative power source:  
1,2 m USB-C-cable included

material:  
mouth-blown crystal glass  
aluminium die-casting  
powder-coated

protection class:  
IP65



### light direction:



### aqu S

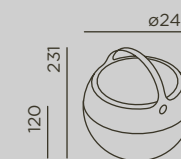

Farbe  
colour

■ true gold

91910-TG

1,5 W/75 lm

■ bright bronze

91910-BB

1,5 W/75 lm

■ pearl white

91910-PW

1,5 W/75 lm

■ jet black

91910-JB

1,5 W/75 lm

### aqu M

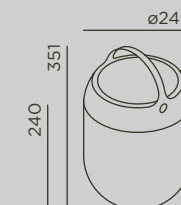

■ true gold

91911-TG

1,5 W/75 lm

■ bright bronze

91911-BB

1,5 W/75 lm

■ pearl white

91911-PW

1,5 W/75 lm

■ jet black

91911-JB

1,5 W/75 lm

Größe in mm  
size in mm

Zubehör  
accessory

Artikel  
article

USB-Ladegerät  
USB-charger

Art.-Nr.  
item no.

55920

Preise in separater Preisliste . prices in separate price list + [www.IP44.de](http://www.IP44.de)

cherry bubbly

NEW

portable



## cherry bubbls

Wenn künftig in immer mehr Gärten vermeintliche Glühwürmchen gesichtet werden, könnte das an cherry bubbls liegen. Die schlicht-edle Lichterkette lässt sich überall in Bäume hängen oder an Balkongeländern befestigen, wo feine Lichtpunkte dem Auge guttun. Und mit ihrer Powerbank als Energiequelle leuchtet sie allerorten fast so flexibel wie ein Glühwürmchen.

If glow worms are allegedly seen in lots more gardens in future, this could be due to cherry bubbls. The simple yet refined light chain can be hung anywhere from trees or fastened to balcony railings, wherever subtle light accents are pleasing to the eye. And the powerbank as energy source makes it almost as flexible as a glow worm, shining all over the place.



# cherry bubbls



cherry bubbls mit Powerbank  
inklusive 3-Stufen-Dimmer.  
cherry bubbls with powerbank  
including 3-step dimming.



## cherry bubbls Design: Klaus Nolting

**Technische Daten:**  
LED  
Lithium-Ionen Akku  
2x 2500 mAh  
2700K  
7 Leuchtkörper

**Anschluss:**  
2 m Zuleitung Lichterkette  
(H05RN-F 2x0,75 mm<sup>2</sup>)  
Powerbank

**Betriebsdauer:**  
· ca. 10 Std. bei 100% (Stufe 3)  
· ca. 20 Std. bei 50% (Stufe 2)  
· ca. 40 Std. bei 25% (Stufe 1)

**3-Stufen-Dimmer**

**Stromversorgung Powerbank:**  
2 m USB-C-Kabel inklusive

zur Aufhängung

**Material:**  
Silikon  
rauchfarbenes Glas

**Schutzart:**  
IP65



**Lichtrichtung:**



**technical information:**  
LED  
lithium-ion battery  
2x 2500 mAh  
2700K  
7 luminaire bodies

**connection:**  
2 m supply cable light chain  
(H05RN-F 2x0,75 mm<sup>2</sup>)  
powerbank

**battery operating time:**  
· approx. 10 hrs. at 100% (level 3)  
· approx. 20 hrs. at 50% (level 2)  
· approx. 40 hrs. at 25% (level 1)

**3-step dimming**

**power source powerbank:**  
2 m USB-C-cable included

for hanging

**material:**  
silicone  
smoke-coloured glass

**protection class:**  
IP65



**light direction:**

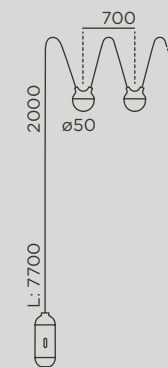

Größe in mm  
size in mm

Farbe colour	Art.-Nr. item no.	Systemleistung system performance
 black	93850	1,5 W/60 lm

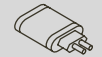
Zubehör accessory	Artikel article	Art.-Nr. item no.
	<b>USB-Ladegerät black</b> USB-charger black	55920-BL

+ cherry bubbls solar . Seite page 48

Preise in separater Preisliste . prices in separate price list + [www.IP44.de](http://www.IP44.de)

fil

Der Würfel hat ja bekanntlich sechs Seiten: bei fil kombinieren sie ein bündig eingelassenes Solarpanel in Seiten aus transluzentem Stoff. Ein zweiter innenliegender Würfel aus transluzentem Polycarbonat sorgt für ein gleichmäßiges Lichtbild.

It's a well-known fact that a cube has six sides. In fil, the sides consist of a solar panel that is embedded flush in translucent fabric. A second inner cube of translucent polycarbonate creates a uniform light effect.

SOLAR



Wechsel zwischen Manuell- und Automatik-Modus über die integrierte Funktionstaste möglich. Im Automatik-Modus schaltet sich die Leuchte bei Dämmerung selbsttätig für 5 Stunden ein. Im Manuell-Modus erfolgt das Ein- und Ausschalten über die Funktionstaste. In beiden Modi ist die Leuchte in 3 Stufen dimmbar. The integrated function button allows you to change over between manual and automatic mode. In automatic mode, the luminaire lights up automatically when it starts to get dark and stays on for 5 hours. In manual mode, the function button is used for switching on and off. In both modes, the luminaire can be dimmed in 3 steps.

Das ist der Stoff, aus dem traumhaftes Licht ist: fil haben wir mit einem witterungs- und UV-beständigen Outdoor-Stoff bespannt, der Helligkeit auf die angenehmste Weise verbreitet. Zu haben ist unsere Bauhaus-inspirierte Leuchte wahlweise in 48 und 71 Zentimetern Höhe. This is the fabric that fabulous light is made of: fil is covered with weatherproof, UV-resistant outdoor fabric that emanates brightness in a very pleasant way. Our Bauhaus-inspired luminaire is available in a height of 48 and 71 centimetres.



fil Design: Klaus Nolting

<b>Technische Daten:</b> LED Lithium-Ionen Akku 4x 2600 mAh 2700K Solarpanel  <b>Optional Wechsel zwischen Manuell- + Automatik-Modus</b>  <b>Betriebsdauer Automatik-Modus:</b> · automat. Einschaltung bei Dämmerung für ca. 5 Std.  <b>Betriebsdauer Manuell-Modus:</b> · ca. 5 Std. bei 100% (Stufe 3) · ca. 10 Std. bei 50% (Stufe 2) · ca. 20 Std. bei 25% (Stufe 1)  <b>3-Stufen-Dimmer</b>	<b>Material:</b> Aluminium pulverbeschichtet <b>Abdeckung: weißer Outdoor-Stoff transluzent</b>  <b>Schutzart:</b> IP65  <b>Lichtrichtung:</b>   <b>Alternative Stromversorgung:</b> 2 m USB-C-Kabel inklusive	<b>technical information:</b> LED lithium-ion battery 4x 2600 mAh 2700K solar panel  optional change between manual + automatic mode  <b>battery operating time automatic mode:</b> · automat. switch-on at dusk for approx. 5 hrs.  <b>battery operating time manual mode:</b> · approx. 5 hrs. at 100% (level 3) · approx. 10 hrs. at 50% (level 2) · approx. 20 hrs. at 25% (level 1)  3-step dimming	<b>material:</b> aluminium powder-coated cover: white outdoor fabric translucent  <b>protection class:</b> IP65  <b>light direction:</b>   <b>alternative power source:</b> 2 m USB-C-cable included
---	---	---	--

fil S	Farbe colour	Art.-Nr. item no.	Systemleistung system performance
		93810-BL	7 W/230 lm

		93811-BL	7 W/230 lm
--	--	----------	------------

Größe in mm size in mm

Zubehör accessory	Artikel article	Art.-Nr. item no.
	USB-Ladegerät black USB-charger black	55920-BL

Preise in separater Preisliste . prices in separate price list + [www.IP44.de](http://www.IP44.de)

# qua

Klein, aber oho: qua ist der Powerwürfel unter den Solarleuchten. Punktet mit kompaktem Maß und eigener Stromversorgung. Durch den optionalen Wechsel vom Manuell- in den Automatik-Modus funktioniert die qua auch völlig autark.

Small, but what a luminaire! qua is the power cube among the solar luminaires. Scores with its compact size and own power supply. The optional changeover from manual to automatic mode makes qua practically self-sufficient.

SOLAR



Über die integrierte Funktionstaste ist ein Wechsel zwischen Manuell- und Automatik-Modus möglich. Im Automatik-Modus schaltet sich die Leuchte bei Dämmerung selbsttätig für 5 Stunden ein. Im Manuell-Modus erfolgt das Ein- und Ausschalten über die Funktionstaste. In beiden Modi ist die Leuchte in 3 Stufen dimmbar. The integrated function button can be used to change over between manual and automatic mode. In automatic mode, the luminaire lights up automatically when it starts to get dark and stays on for 5 hours. In manual mode, the function button is used for switching on and off. In both modes, the luminaire can be dimmed in 3 steps.

## qua Design: Klaus Nolting



**Technische Daten:**  
LED  
Lithium-Ionen Akku  
2x 2000 mAh  
2700K  
Solarpanel

Optional Wechsel zwischen Manuell- + Automatik-Modus

**Betriebsdauer Automatik-Modus:**  
· automat. Einschaltung bei Dämmerung für ca. 5 Std.

**Betriebsdauer Manuell-Modus:**  
· ca. 7 Std. bei 100% (Stufe 3)  
· ca. 14 Std. bei 50% (Stufe 2)  
· ca. 32 Std. bei 25% (Stufe 1)

**3-Stufen-Dimmer**

**Material:**  
Aluminiumguss lackiert  
Polycarbonat matt

**Schutzart:**  
IP65



**Lichtrichtung:**



**Alternative Stromversorgung:**  
2 m USB-C-Kabel inklusive

**technical information:**  
LED  
lithium-ion battery  
2x 2000 mAh  
2700K  
solar panel

optional change between manual + automatic mode

**battery operating time automatic mode:**  
· automat. switch-on at dusk for approx. 5 hrs.

**battery operating time manual mode:**  
· approx. 7 hrs. at 100% (level 3)  
· approx. 14 hrs. at 50% (level 2)  
· approx. 32 hrs. at 25% (level 1)

**3-step dimming**

**material:**  
aluminium die-casting lacquered  
polycarbonate matt

**protection class:**  
IP65



**light direction:**



**alternative power source:**  
2 m USB-C-cable included

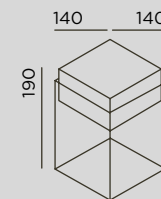

Größe in mm  
size in mm

Farbe colour	Art.-Nr. item no.	Systemleistung system performance
bright bronze	93825-BB	2,1 W/75 lm
pearl white	93825-PW	2,1 W/75 lm
jet black	93825-JB	2,1 W/75 lm

Zubehör accessory	Artikel article	Art.-Nr. item no.
	USB-Ladegerät black USB-charger black	55920-BL

Preise in separater Preisliste . prices in separate price list + [www.IP44.de](http://www.IP44.de)

# wall

	como	122
	como one	126
	cut	128
	cut control	132
	cut one	134
	dia	138
	gap Q	144
	gap X	148
	gap Y	152
<i>NEW</i>	gic	156
	intro	164
	lisc	168
	pip	172
	scap	176
	scap one	180
	slat	184
	slat one	188
	stic	192
	stic control	196



# como

Ihr Korpus wird aus Aluminium gegossen. Ihr Herz ist unsere etablierte LED-Technik. Ihr Licht fällt klar fokussiert durch eine hochwertige Linsenoptik. Was braucht eine Außenleuchte mehr?

The body is casted from aluminium. The heart consists of our proven LED technology. The light falls with a clear focus thanks to a top quality optical lens. What more does an outside luminaire want?



product design award  
2011



reddot design award  
winner 2010



Designpreis Deutschland 2011  
NOMINIERT

DESIGN PLUS

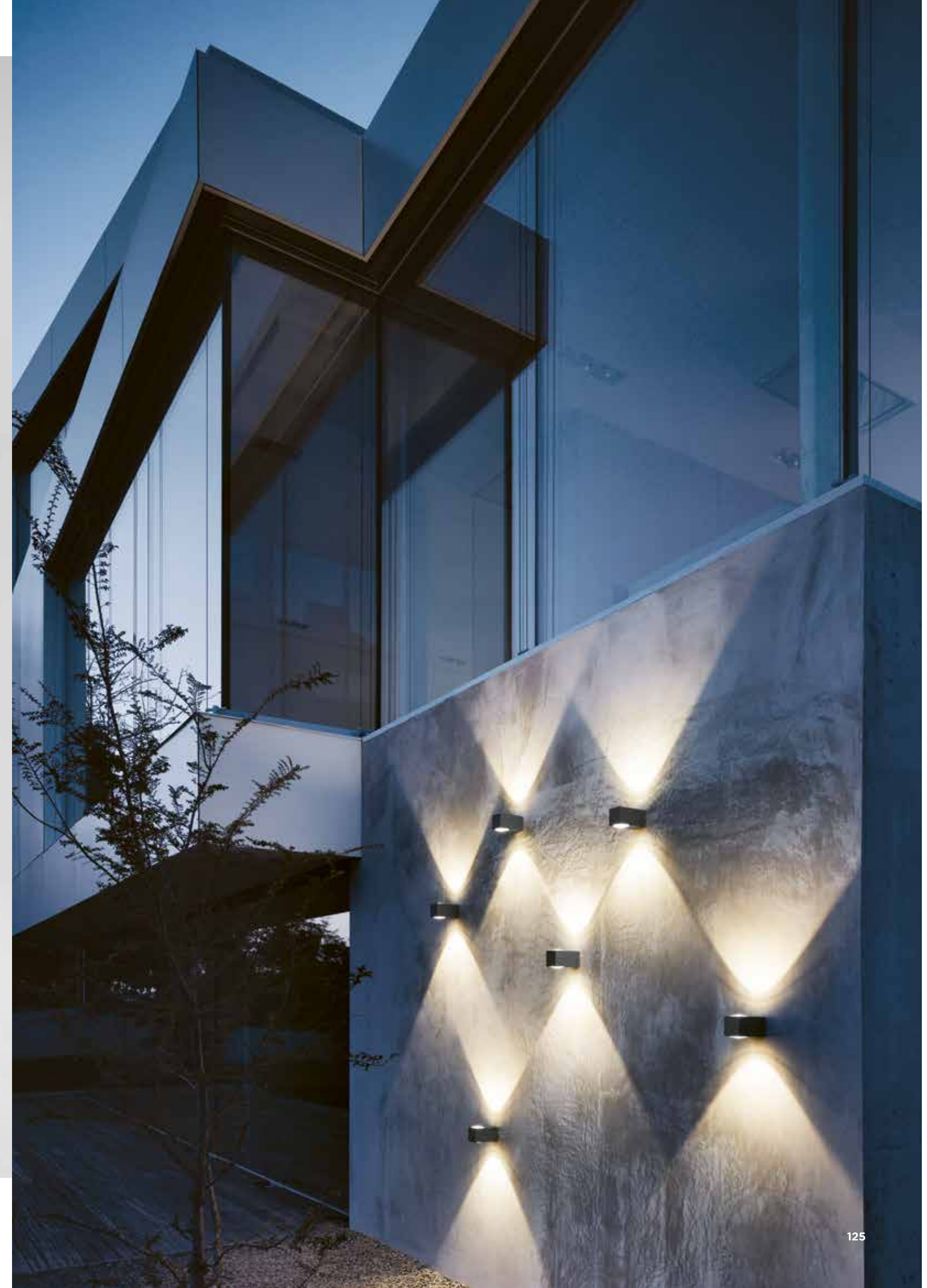

wall

# como one

Klare Formensprache und filigrane Ästhetik vereint in einem gegossenen Aluminiumkorpus. Die Leuchte ist mit modernster LED-Technik ausgestattet und wahlweise als Up- oder Downlight einsetzbar. Die perfekte Ergänzung zur Leuchte como.

Clear design language and a filigree appearance combined in a casted aluminium body. The luminaire is fitted with state-of-the-art LED technology and can be used either as up- or downlight. The perfect addition to the luminaire como.



reddot design award  
winner 2010









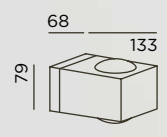

DESIGN PLUS

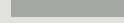
## como + como one Design: IP44.DE

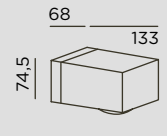

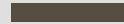
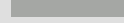
<b>Lichttechnik:</b> 230V Power LED 2700K L70/50.000 h  dimmbar  <b>Installation:</b> 1x Kabeleinführung; Anschlussklemme 3x 1,5 mm <sup>2</sup>	<b>Material:</b> Aluminiumguss pulverbeschichtet Glaslinse  <b>Schutzart:</b> IP65    <b>Lichtrichtung:</b> como    como one  	light technology: 230V Power LED 2700K L70/50.000 h  dimmable  installation: 1x cable entry point; connection terminal 3x 1,5 mm <sup>2</sup>	material: aluminium die-casting powder-coated glass lens  protection class: IP65    light direction; como    como one  
--	---	---	--

como	Farbe colour	Art.-Nr. item no.	Systemleistung system performance
	 anthracite RAL 7016	92180-27-AN	12 W/553 lm
	 cool brown	92180-27-CB	12 W/553 lm
	 space grey	92180-27-SG	12 W/553 lm
	 pure white RAL 9016	92180-27-WH	12 W/553 lm
	 deep black RAL 9005	92180-27-BL	12 W/553 lm
	 anthracite RAL 7016	92181-27-AN	6 W/276 lm
	 cool brown	92181-27-CB	6 W/276 lm
	 space grey	92181-27-SG	6 W/276 lm
	 pure white RAL 9016	92181-27-WH	6 W/276 lm
	 deep black RAL 9005	92181-27-BL	6 W/276 lm

+ como poller . Seite page 224

Preise in separater Preisliste . prices in separate price list + [www.IP44.de](http://www.IP44.de)



cut



wall

# cut

Kantig. Konsequenz. Konturiert. cut ist ein klares architektonisches Statement und Lichtblick für jede Fassade. Als klassisches Up- und Downlight spendet sie angenehm akzentuiertes Licht.

Contemporary. Consistent. Contoured. cut is a clear architectural statement and a highlight for every facade. As a classic up and downlight, it provides pleasantly accentuated light.



## cut Design: IP44.DE

**Lichttechnik:**  
230V Power LED  
2700K  
L70/50.000 h

**Reflektor:** Flood  
dimmbar

**Installation:**  
2x Kabeleinführung;  
Anschlussklemme  
3x 1,5 mm<sup>2</sup>

**Material:**  
Aluminiumguss  
pulverbeschichtet  
Sicherheitsglas klar

**Schutzart:**  
IP65



**Lichtrichtung:**



**light technology:**  
230V Power LED  
2700K  
L70/50.000 h

**reflector:** flood  
dimmbable

**installation:**  
2x cable entry point;  
connection terminal  
3x 1,5 mm<sup>2</sup>

**material:**  
aluminium die-casting  
powder-coated  
safety glass clear

**protection class:**  
IP65



**light direction:**

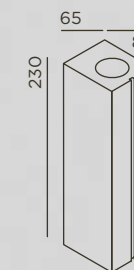

Größe in mm  
size in mm

Farbe colour	Art.-Nr. item no.	Systemleistung system performance
anthracite RAL 7016	91191-27-AN	16W/1118 lm
cool brown	91191-27-CB	16W/1118 lm
space grey	91191-27-SG	16W/1118 lm
pure white RAL 9016	91191-27-WH	16W/1118 lm
deep black RAL 9005	91191-27-BL	16W/1118 lm

+ cut control . Seite page 132  
+ cut one . Seite page 134  
+ cut poller . Seite page 228

Preise in separater Preisliste . prices in separate price list + [www.IP44.de](http://www.IP44.de)

# cut control

Sicherheit und Ästhetik vereint in einer Leuchte: cut control mit integriertem Bewegungsmelder lässt sich mit identischen Proportionen wunderbar als Ergänzung zum Up- und Downlight cut einsetzen.

A luminaire offering security and aesthetics all in one: cut control features an integrated motion detector and has the same proportions as the cut up and downlight for a perfect pairing.



Dämmerungseinstellung zwischen 10-2000 Lux + Zeiteinstellung zwischen 5 Sek. und 8 Min. variabel einstellbar. Twilight setting between 10-2000 lux + time setting between 5 sec. and 8 min. variably adjustable.



## cut control Design: IP44.DE

**Lichttechnik:**  
230V Power LED  
2700K  
L70/50.000 h

**Reflektor:** Flood

Erfassungswinkel 120°  
Zeiteinstellung 5 Sek. – 8 Min.  
Dämmerungseinstellung  
10-2000 Lux; Reichweite 9 m

**Installation:**  
2x Kabeleinführung;  
Anschlussklemme  
4x 1,5 mm<sup>2</sup>

**Material:**  
Aluminiumguss  
pulverbeschichtet  
Sicherheitsglas klar

**Schutzart:**  
IP44



**Lichtrichtung:**



**light technology:**  
230V Power LED  
2700K  
L70/50.000 h

**reflector:** flood

detection angle 120°  
time setting 5 sec. – 8 min.  
twilight setting  
10-2000 lux; range 9 m

**installation:**  
2x cable entry point;  
connection terminal  
4x 1,5 mm<sup>2</sup>

**material:**  
aluminium die-casting  
powder-coated  
safety glass clear

**protection class:**  
IP44



**light direction:**

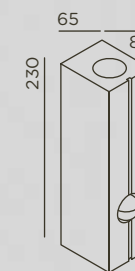

Größe in mm  
size in mm

Farbe colour	Art.-Nr. item no.	Systemleistung system performance
anthracite RAL 7016	91190-27-AN	16 W/1118 lm
cool brown	91190-27-CB	16 W/1118 lm
space grey	91190-27-SG	16 W/1118 lm
pure white RAL 9016	91190-27-WH	16 W/1118 lm
deep black RAL 9005	91190-27-BL	16 W/1118 lm

+ cut . Seite page 128  
+ cut one . Seite page 134  
+ cut poller . Seite page 228

Preise in separater Preisliste . prices in separate price list + [www.IP44.de](http://www.IP44.de)

cut one



wall

# cut one

Keine halben Sachen machen wir mit cut one, wohl aber ein halbes Maß: Als reines Downlight – das sich selbstverständlich auch als Uplight montieren lässt - kombiniert cut's kleine Schwester eine kompakte Form mit klar-fokussiertem Licht.

We don't do things by halves with cut one, but we do offer half the size: as a pure downlight, which can naturally also be installed as an uplight, cut's little sister combines a compact shape with a clearly focussed light.

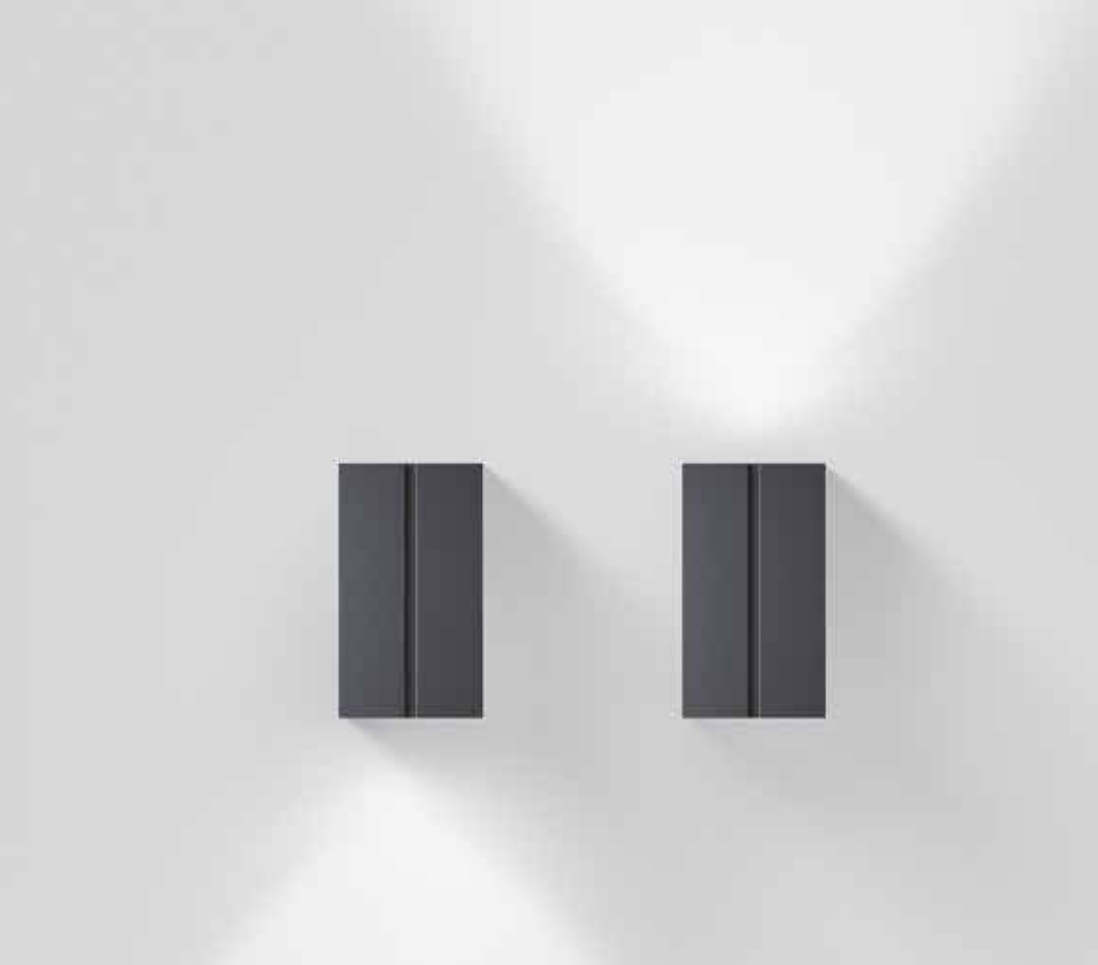

## cut one Design: IP44.DE

**Lichttechnik:**  
230V Power LED  
2700K  
L70/50.000 h

**Reflektor: Flood**  
dimmbar

**Installation:**  
2x Kabeleinführung;  
Anschlussklemme  
3x 1,5 mm<sup>2</sup>

**Material:**  
Aluminiumguss  
pulverbeschichtet  
Sicherheitsglas klar

**Schutzart:**  
IP65



**Lichtrichtung:**



**light technology:**  
230V Power LED  
2700K  
L70/50.000 h

**reflector: flood**  
dimmbable

**installation:**  
2x cable entry point;  
connection terminal  
3x 1,5 mm<sup>2</sup>

**material:**  
aluminium die-casting  
powder-coated  
safety glass clear

**protection class:**  
IP65



**light direction:**

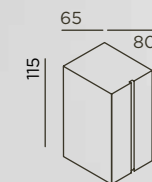

Größe in mm  
size in mm

Farbe colour	Art.-Nr. item no.	Systemleistung system performance
anthracite RAL 7016	91192-AN	8 W/559 lm
cool brown	91192-CB	8 W/559 lm
space grey	91192-SG	8 W/559 lm
pure white RAL 9016	91192-WH	8 W/559 lm
deep black RAL 9005	91192-BL	8 W/559 lm

+ cut . Seite page 128  
+ cut control . Seite page 132  
+ cut poller . Seite page 228

Preise in separater Preisliste . prices in separate price list + [www.IP44.de](http://www.IP44.de)

dia



wall

dia



wall

dia

Der Clou dieser modernen Interpretation einer klassischen Laterne ist die Kombination von geradlinigem Rahmen aus Aluminiumguss und geblasenem Glaskörper. Unverwechselbar mit dem profilierten, reflektierenden Acrylstab, der in dem rauchfarbenen Glas zu schweben scheint.

The special feature of this modern interpretation of a traditional lantern is the way it combines a straight-line aluminium die-casting frame with a blown glass body. Unmistakable with the profiled, reflecting acrylic rod that seems to float in the smoke-coloured glass.



 **reddot award**  
winner 2019

 **INNOVATIVE INTERIOR**  
winner

 **GERMAN DESIGN AWARD WINNER 2019**



**dia** Design: Sebastian David Büscher

**Lichttechnik:**  
230V Power LED  
2700K  
L70/50.000 h

dimmbar

**Installation:**  
2x Kabeleinführung;  
Anschlussklemme  
3x 1,5 mm<sup>2</sup>

**Material:**  
Aluminiumguss  
pulverbeschichtet  
rauchfarbenes Glas

**Schutzart:**  
IP65



**Lichtrichtung:**



light technology:  
230V Power LED  
2700K  
L70/50.000 h

dimmable

**installation:**  
2x cable entry point;  
connection terminal  
3x 1,5 mm<sup>2</sup>

material:  
aluminium die-casting  
powder-coated  
smoke-coloured glass

protection class:  
IP65



light direction:

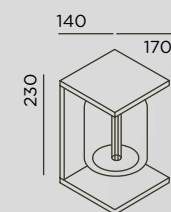

Größe in mm  
size in mm

**Farbe**  
colour

 **anthracite**  
RAL 7016

 **deep black**  
RAL 9005

**Art.-Nr.**  
item no.

91250-AN

91250-BL

**Systemleistung**  
system performance

6 W/88 lm

6 W/88 lm

+ dia poller . Seite page 232

Preise in separater Preisliste . prices in separate price list + [www.IP44.de](http://www.IP44.de)



gap Q



wall

# gap Q

gap ist ein echter Lichtblick und inszeniert mit seiner kubisch anmutenden Formgebung den Außenraum eines jeden Objektes ganz neu. Das quadratische Format der gap Q ist richtungslos, kubisch und ruhig und schafft damit ein stimmiges Erscheinungsbild.

gap is a real bright spot whose cubic shape creates a completely new setting for the surroundings of every building. The square format of the gap Q is undirectional, cubic and calm and so creates a harmonious appearance.



## gap Q Design: Klaus Nolting



**Lichttechnik:**  
230V Power LED  
2700K  
L70/50.000 h

dimmbar

**Installation:**  
2x Kabeleinführung;  
Anschlussklemme  
3x 1,5 mm<sup>2</sup>

**Material:**  
Aluminiumguss  
pulverbeschichtet  
Sicherheitsglas satiniert

**Schutzart:**  
IP65



**Lichtrichtung:**



**light technology:**  
230V Power LED  
2700K  
L70/50.000 h

dimmable

**installation:**  
2x cable entry point;  
connection terminal  
3x 1,5 mm<sup>2</sup>

**material:**  
aluminium die-casting  
powder-coated  
safety glass satined

**protection class:**  
IP65



**light direction:**

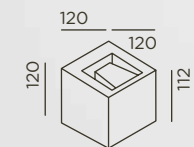





Größe in mm  
size in mm

**Farbe**  
colour

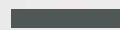
**Art.-Nr.**  
item no.

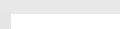
**Systemleistung**  
system performance

 anthracite RAL 7016	91100-27-Q-AN	12 W/350 lm
 cool brown	91100-27-Q-CB	12 W/350 lm
 space grey	91100-27-Q-SG	12 W/350 lm
 pure white RAL 9016	91100-27-Q-WH	12 W/350 lm
 deep black RAL 9005	91100-27-Q-BL	12 W/350 lm

Preise in separater Preisliste . prices in separate price list + [www.IP44.de](http://www.IP44.de)

gap X



# gap X

Mit seinen ausgewogenen Proportionen wird die gap X nahezu allen architektonischen Anforderungen gerecht. Das schlanke, liegende Format betont die Horizontale, die fein aufeinander abgestimmten Radien sorgen für einen schönen Linienfluss innerhalb des Gehäuses.

With its balanced proportions, the gap X meets practically all architectural requirements. The slim, lying format underlines the horizontal plane, with finely coordinated radii creating an attractive flow of lines within the housing.



## gap X Design: Klaus Nolting



<b>Lichttechnik:</b> 230V Power LED 2700K L70/50.000 h  dimmbar  <b>Installation:</b> 2x Kabeleinführung; Anschlussklemme 3x 1,5 mm <sup>2</sup>	<b>Material:</b> Aluminiumguss pulverbeschichtet Sicherheitsglas satiniert  <b>Schutzart:</b> IP65   <b>Lichtrichtung:</b> 	<b>light technology:</b> 230V Power LED 2700K L70/50.000 h  dimmable  <b>installation:</b> 2x cable entry point; connection terminal 3x 1,5 mm <sup>2</sup>	<b>material:</b> aluminium die-casting powder-coated safety glass satined  <b>protection class:</b> IP65   <b>light direction:</b> 
--	---	---	---

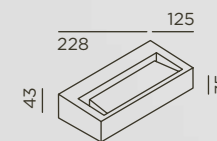

Größe in mm  
size in mm

Farbe colour	Art.-Nr. item no.	Systemleistung system performance
 anthracite RAL 7016	91100-27-X-AN	12 W/272 lm
 cool brown	91100-27-X-CB	12 W/272 lm
 space grey	91100-27-X-SG	12 W/272 lm
 pure white RAL 9016	91100-27-X-WH	12 W/272 lm
 deep black RAL 9005	91100-27-X-BL	12 W/272 lm

Preise in separater Preisliste . prices in separate price list + [www.IP44.de](http://www.IP44.de)

gap Y



wall

# gap Y

Die schlanke Frontansicht der gap Y wird durch die flachen Winkel erzeugt. Durch die leicht zur Hauswand gekippte Lichtaustrittsfläche wird eine perfekte Ausleuchtung der Fassade erreicht.

The slim-line front view of the gap Y is generated by the flat angles. The light output surface is tilted slightly towards the house wall for perfect illumination of the facade.



## gap Y Design: Klaus Nolting



**Lichttechnik:**  
230V Power LED  
2700K  
L70/50.000 h

dimmbar

**Installation:**  
2x Kabeleinführung;  
Anschlussklemme  
3x 1,5 mm<sup>2</sup>

**Material:**  
Aluminiumguss  
pulverbeschichtet  
Sicherheitsglas satiniert

**Schutzart:**  
IP65



**Lichtrichtung:**



**light technology:**  
230V Power LED  
2700K  
L70/50.000 h

dimmable

**installation:**  
2x cable entry point;  
connection terminal  
3x 1,5 mm<sup>2</sup>

**material:**  
aluminium die-casting  
powder-coated  
safety glass satined

**protection class:**  
IP65



**light direction:**

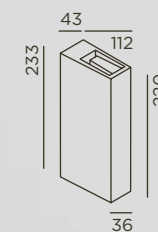

Größe in mm  
size in mm

Farbe colour	Art.-Nr. item no.	Systemleistung system performance
anthracite RAL 7016	91100-27-Y-AN	12 W/270 lm
cool brown	91100-27-Y-CB	12 W/270 lm
space grey	91100-27-Y-SG	12 W/270 lm
pure white RAL 9016	91100-27-Y-WH	12 W/270 lm
deep black RAL 9005	91100-27-Y-BL	12 W/270 lm

Preise in separater Preisliste . prices in separate price list + [www.IP44.de](http://www.IP44.de)

gic

NEW



gic

Eine Basis. Drei Oberflächen. Sieben ganz unterschiedliche Cover: gic bietet schier unzählige Gestaltungsmöglichkeiten. Ihr eleganter Korpus (zu haben in den Farben anthracite, pure white oder deep black) wird mit einer individuellen Akzentfläche ausgestattet, die jeder Leuchte einen persönlichen Ton verleiht.

One base. Three surfaces. Seven totally different covers: gic offers virtually countless creative possibilities. The elegant body (available in the colours anthracite, pure white or deep black) comes with an individual accent surface that gives every luminaire its own personal shade.



wall





deep black + brass brushed



pure white + brass brushed



deep black + stainless steel polished



deep black + deep black



anthracite + stainless steel brushed



anthracite + stainless steel polished



pure white + stainless steel brushed



pure white + brass polished



deep black + brass polished

**gic** Design: Klaus Nolting



**Lichttechnik:**  
230V Power LED  
2700K  
L70/50.000 h

dimmbar

**Installation:**  
2x Kabeleinführung;  
Anschlussklemme  
3x 1,5 mm<sup>2</sup>

**Material:**  
Aluminiumguss  
pulverbeschichtet  
Glas satiniert

**Schutzart:**  
IP65



**Lichtrichtung:**



**light technology:**  
230V Power LED  
2700K  
L70/50.000 h

dimmable

**installation:**  
2x cable entry point;  
connection terminal  
3x 1,5 mm<sup>2</sup>

**material:**  
aluminium die-casting  
powder-coated  
glass satinied

**protection class:**  
IP65



**light direction:**



**gic base**

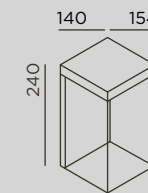

**Farbe**  
colour

**Art.-Nr.**  
item no.

**Systemleistung**  
system performance

	anthracite RAL 7016	93250-AN	8 W/360 lm
	pure white RAL 9016	93250-WH	8 W/360 lm
	deep black RAL 9005	93250-BL	8 W/360 lm

**Erforderliches Zubehör** required accessory

**gic cover**



**Farbe**  
colour

**Art.-Nr.**  
item no.

**Material**  
material

	anthracite RAL 7016	93250-C-AN	Edelstahl pulverbeschichtet stainless steel powder-coated
	pure white RAL 9016	93250-C-WH	Edelstahl pulverbeschichtet stainless steel powder-coated
	deep black RAL 9005	93250-C-BL	Edelstahl pulverbeschichtet stainless steel powder-coated
	brass polished	93250-CB-PO	Messing poliert brass polished
	brass brushed	93250-CB-BR	Messing gebürstet brass brushed
	stainless steel polished	93250-CS-PO	Edelstahl poliert stainless steel polished
	stainless steel brushed	93250-CS-BR	Edelstahl gebürstet stainless steel brushed

**Größe in mm**  
size in mm

Preise in separater Preisliste . prices in separate price list + [www.IP44.de](http://www.IP44.de)

intro



# intro

Einfach ist immer am schwersten, so heißt es, aber intro ist das denkbar überzeugendste Gegenbeispiel: ein schwer sympathischer Würfel mit gerundeten Kanten, ausgestattet mit modernster LED-Technik.

They say that simple is always difficult, but intro is the most convincing counter-argument: a truly appealing cube with rounded edges, fitted with state-of-the-art LED technology.



## intro Design: IP44.DE



**Lichttechnik:**  
230V Power LED  
2700K  
L70/50.000 h

dimmbar

**Installation:**  
2x Kabeleinführung;  
Anschlussklemme  
3x 1,5 mm<sup>2</sup>

**Material:**  
Aluminiumguss  
pulverbeschichtet  
Borosilikatglas satiniert

**Schutzart:**  
IP65



**Lichtrichtung:**



**light technology:**  
230V Power LED  
2700K  
L70/50.000 h

dimmable

**installation:**  
2x cable entry point;  
connection terminal  
3x 1,5 mm<sup>2</sup>

**material:**  
aluminium die-casting  
powder-coated  
borosilicate glass satined

**protection class:**  
IP65



**light direction:**

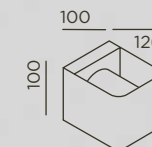

Größe in mm  
size in mm

Farbe colour	Art.-Nr. item no.	Systemleistung system performance
anthracite RAL 7016	92491-27-AN	15 W/451 lm
cool brown	92491-27-CB	15 W/451 lm
space grey	92491-27-SG	15 W/451 lm
pure white RAL 9016	92491-27-WH	15 W/451 lm
deep black RAL 9005	92491-27-BL	15 W/451 lm

Preise in separater Preisliste . prices in separate price list + [www.IP44.de](http://www.IP44.de)

lisc



wall

# lisc

„Weniger ist mehr“ – mit lisc haben wir dieses gestalterische Credo in eine klassisch reduzierte, superflache Wand- und Deckenleuchte übersetzt. Das dickwandige, von innen opalweiße Glas betont die Wertigkeit der Leuchte.

“Less is more” – our lisc translates this design concept into a classically reduced super-flat wall and ceiling luminaire. The thick-walled glass is opal-white on the inside and underlines the high quality of the luminaire.







Die Wandleuchte lisc number stellt mit bis zu drei Ziffern eine elegante, dezente Möglichkeit der Hausnummernbeleuchtung dar. The wall luminaire lisc number features up to three numbers as an elegant, discreet house number light.

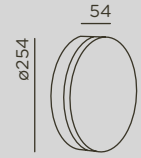
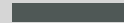

## lisc Design: Klaus Nolting

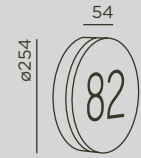
<b>Lichttechnik:</b> 230V Power LED 2700K L70/50.000 h  dimmbar  <b>Installation:</b> 2x Kabeleinführung; Anschlussklemme 3x 1,5 mm <sup>2</sup>	<b>Material:</b> Aluminiumguss pulverbeschichtet Kristallglas, innen opalweiß  <b>Schutzart:</b> IP65    <b>Lichtrichtung:</b> 	<b>light technology:</b> 230V Power LED 2700K L70/50.000 h  dimmable  <b>installation:</b> 2x cable entry point; connection terminal 3x 1,5 mm <sup>2</sup>	<b>material:</b> aluminium die-casting powder-coated crystal glass, opal-white inside  <b>protection class:</b> IP65    <b>light direction:</b> 
--	---	---	--

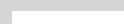
lisc	Farbe colour	Art.-Nr. item no.	Systemleistung system performance
	 anthracite RAL 7016	91210-AN	14 W/815 lm
	 pure white RAL 9016	91210-WH	14 W/815 lm
	 anthracite RAL 7016 max. 3 Ziffern folienkaschiert, mittelgrau max. 3 digits foil laminated, medium grey	91210-NO-AN	14 W/815 lm
	 pure white RAL 9016 max. 3 Ziffern folienkaschiert, mittelgrau max. 3 digits foil laminated, medium grey	91210-NO-WH	14 W/815 lm

Größe in mm  
size in mm

+ lisc ceiling . Seite page 202

Preise in separater Preisliste . prices in separate price list + [www.IP44.de](http://www.IP44.de)

pip



wall

pip

Pure Geometrie in einer einzigen Leuchte: Der kugelförmige Leuchtkörper der pip ist axial drehbar gelagert und scheint in der kubischen Grundform zu schweben. Die Flexibilität dieser formschönen Leuchte setzt jedes Objekt ins beste Licht.





Pure geometry in a single luminaire: pip's spherical luminaire body is pivot-mounted in the axial plane and seems to hover in the basic cube shape. The flexibility offered by this attractive luminaire puts every object in the best light.







240°

pip Design: Klaus Nolting

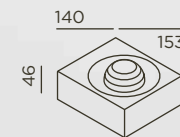

<b>Lichttechnik:</b> 230V Power LED 2700K L70/50.000 h  <b>dimmbar</b>  <b>Installation:</b> 1x Kabeleinführung; Anschlussklemme 3x 1,5 mm <sup>2</sup>	<b>Material:</b> Aluminiumguss pulverbeschichtet Sicherheitsglas satiniert  <b>Schutzart:</b> IP65    <b>Lichtrichtung:</b> 	<b>light technology:</b> 230V Power LED 2700K L70/50.000 h  <b>dimmmable</b>  <b>installation:</b> 1x cable entry point; connection terminal 3x 1,5 mm <sup>2</sup>	<b>material:</b> aluminium die-casting powder-coated safety glass satined  <b>protection class:</b> IP65    <b>light direction:</b> 
---	---	---	---

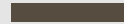
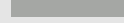

Farbe colour	Art.-Nr. item no.	Systemleistung system performance
 anthracite RAL 7016	91120-27-AN	6 W/273 lm
 cool brown	91120-27-CB	6 W/273 lm
 space grey	91120-27-SG	6 W/273 lm
 pure white RAL 9016	91120-27-WH	6 W/273 lm
 deep black RAL 9005	91120-27-BL	6 W/273 lm

Größe in mm  
size in mm

+ pip poller . Seite page 282

Preise in separater Preisliste . prices in separate price list + [www.IP44.de](http://www.IP44.de)



scap



wall

# scap

Unser alter Klassiker neu aufgelegt: Gut möglich, dass ihre Form dem einen oder anderen bekannt vorkommt, denn scap gehörte zu den Klassikern im IP44.DE-Portfolio. Unsere Up & Down-Leuchte ist mit modernster Lichttechnik ausgestattet und gleichzeitig haben wir ihre Silhouette sanft verschlankt und damit zeitgemäß angepasst.

A design classic in a new version: if the shape seems familiar to some people, that is because scap is one of the classic products in the IP44.DE range. Our up- & downlight is fitted with state-of-the-art lighting technology; at the same time, we have gently streamlined the silhouette to bring it up to date.







## scap Design: IP44.DE

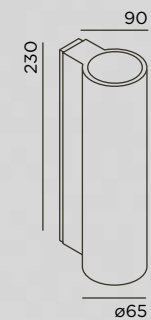

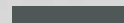
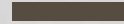
<b>Lichttechnik:</b> 230V Power LED 2700K L70/50.000 h	<b>Material:</b> Aluminiumguss pulverbeschichtet Sicherheitsglas klar	light technology: 230V Power LED 2700K L70/50.000 h	material: aluminium die-casting powder-coated safety glass clear
<b>Reflektor:</b> Flood  dimmbar	<b>Schutzart:</b> IP65  	reflector: flood  dimmable	protection class: IP65  
<b>Installation:</b> 2x Kabeleinführung; Anschlussklemme 3x 1,5 mm <sup>2</sup>	<b>Lichtrichtung:</b> 	installation: 2x cable entry point; connection terminal 3x 1,5 mm <sup>2</sup>	light direction: 



Farbe colour	Art.-Nr. item no.	Systemleistung system performance
 anthracite RAL 7016	92271-AN	16 W/906 lm
 cool brown	92271-CB	16 W/906 lm
 space grey	92271-SG	16 W/906 lm
 pure white RAL 9016	92271-WH	16 W/906 lm
 deep black RAL 9005	92271-BL	16 W/906 lm

Größe in mm  
size in mm

+ scap one . Seite page 180

Preise in separater Preisliste . prices in separate price list + [www.IP44.de](http://www.IP44.de)

scap one



wall

# scap one

Nur wer sich ändert, bleibe sich treu, heißt es, und eine eindrucksvolle Bestätigung dieser Regel ist scap one. Einsetzbar als Up- oder Downlight lässt sie sich wunderbar mit unserem Klassiker scap kombinieren.

They say you have to change to remain true to yourself, and scap one gives impressive confirmation of this rule. When used as an up- or downlight, it works great in combination with our classic scap.





## scap one Design: IP44.DE

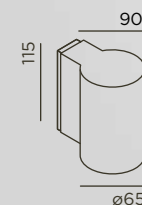

<b>Lichttechnik:</b> 230V Power LED 2700K L70/50.000 h  <b>Reflektor: Flood</b>  dimmbar  <b>Installation:</b> 1x Kabeleinführung; Anschlussklemme 3x 1,5 mm <sup>2</sup>	<b>Material:</b> Aluminiumguss pulverbeschichtet Sicherheitsglas klar  <b>Schutzart:</b> IP65    <b>Lichtrichtung:</b> 	light technology: 230V Power LED 2700K L70/50.000 h  reflector: flood  dimmable  installation: 1x cable entry point; connection terminal 3x 1,5 mm <sup>2</sup>	material: aluminium die-casting powder-coated safety glass clear  protection class: IP65    light direction: 
---	--	---	--

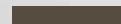
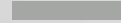

Farbe colour	Art.-Nr. item no.	Systemleistung system performance
 anthracite RAL 7016	92272-AN	8 W/453 lm
 cool brown	92272-CB	8 W/453 lm
 space grey	92272-SG	8 W/453 lm
 pure white RAL 9016	92272-WH	8 W/453 lm
 deep black RAL 9005	92272-BL	8 W/453 lm

Größe in mm  
size in mm

+ scap . Seite page 176

Preise in separater Preisliste . prices in separate price list + [www.IP44.de](http://www.IP44.de)

slat



wall

# slat

slat stellt sich in eleganter Weise auf jede lichttechnische Situation ein: Zwei unabhängig voneinander um 240° drehbare Wallwasher sind stufenlos verstellbar. Ein echtes Lichtwerkzeug für jede Fassade!

slat adapts elegantly to the specific lighting situation, with two fully variable, by 240° independently rotating wallwashers. A genuine lighting tool for every facade!



reddot award 2017  
winner





## slat Design: Klaus Nolting

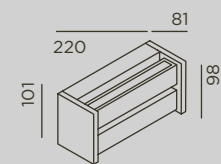

<b>Lichttechnik:</b> 230V Power LED 2700K L70/50.000 h  dimmbar  <b>Installation:</b> 2x Kabeleinführung; Anschlussklemme 3x 1,5 mm <sup>2</sup>	<b>Material:</b> Aluminiumguss pulverbeschichtet Sicherheitsglas satiniert  <b>Schutzart:</b> IP65    <b>Lichttrichtung:</b> 	<b>light technology:</b> 230V Power LED 2700K L70/50.000 h  dimmable  <b>installation:</b> 2x cable entry point; connection terminal 3x 1,5 mm <sup>2</sup>	<b>material:</b> aluminium die-casting powder-coated safety glass satined  <b>protection class:</b> IP65    <b>light direction:</b> 
--	--	---	---

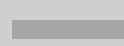
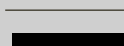

Farbe colour	Art.-Nr. item no.	Systemleistung system performance
 anthracite RAL 7016	91130-27-AN	16 W/675 lm
 cool brown	91130-27-CB	16 W/675 lm
 space grey	91130-27-SG	16 W/675 lm
 pure white RAL 9016	91130-27-WH	16 W/675 lm
 deep black RAL 9005	91130-27-BL	16 W/675 lm

Größe in mm  
size in mm

- + slat one . Seite page 188
- + slat ceiling . Seite page 210
- + slat poller . Seite page 298
- + slat spike . Seite page 302

Preise in separater Preisliste . prices in separate price list + [www.IP44.de](http://www.IP44.de)

slat one



wall

# slat one

Die kleine Schwester der slat mit einem einzelnen, schwenkbaren Lichtbalken erweitert die Produktfamilie, um für jede Gestaltungsidee die passende Ausführung zu bieten. Die slat one eignet sich auch hervorragend für den bodennahen Einsatz, um zum Beispiel Treppentufen oder Wege ins beste Licht zu setzen.

slat's little sister with one single swivelling light bar supplements the product family to offer the perfect solution for every design idea. slat one is also ideal for low-level use where it puts steps or paths, for example, in the best possible light.



## slat one Design: Klaus Nolting



**Lichttechnik:**  
230V Power LED  
2700K  
L70/50.000 h

**dimmbar**

**Installation:**  
1x Kabeleinführung;  
Anschlussklemme  
3x 1,5 mm<sup>2</sup>

**Material:**  
Aluminiumguss  
pulverbeschichtet  
Sicherheitsglas satiniert

**Schutzart:**  
IP65



**Lichttrichtung:**

**light technology:**  
230V Power LED  
2700K  
L70/50.000 h

**dimmbare**

**installation:**  
1x cable entry point;  
connection terminal  
3x 1,5 mm<sup>2</sup>

**material:**  
aluminium die-casting  
powder-coated  
safety glass satined

**protection class:**  
IP65



**light direction:**

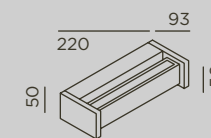

Größe in mm  
size in mm

Farbe colour	Art.-Nr. item no.	Systemleistung system performance
anthracite RAL 7016	91131-27-AN	8 W/280 lm
cool brown	91131-27-CB	8 W/280 lm
space grey	91131-27-SG	8 W/280 lm
pure white RAL 9016	91131-27-WH	8 W/280 lm
deep black RAL 9005	91131-27-BL	8 W/280 lm

- + slat . Seite page 184
- + slat ceiling . Seite page 210
- + slat poller . Seite page 298
- + slat spike . Seite page 302

Preise in separater Preisliste . prices in separate price list + [www.IP44.de](http://www.IP44.de)



stic



wall

# stic

Wer Natur oder Architektur ins beste Licht setzen will, kommt um stic nicht herum. Bislang rein als Bodenstrahler im Einsatz, erhält sie jetzt Konsole und schwenkbare Gelenk für die Montage an Wand, Decke oder Boden – überall dort, wo ebenso brillantes wie fokussiertes Licht gebraucht wird.

If you want to put nature or architecture in the best light, you can't avoid stic. Designed originally as a pure ground spotlight, it has now been fitted with a bracket and swivel joint for mounting to the wall, ceiling or floor – wherever there is a need for both brilliant and focused light.



Der Leuchtenkopf ist dreh- und schwenkbar. The luminaire head can be turned and swiveled.



## stic Design: Klaus Nolting



**Lichttechnik:**  
230V Power LED  
2700K  
L70/50.000 h

**Reflektor:** Flood

dimmbar

**Installation:**  
2x Kabeleinführung;  
Anschlussklemme  
3x 1,5 mm<sup>2</sup>

**Material:**  
Kopf: Aluminiumguss  
pulverbeschichtet  
Konsole: Edelstahl  
pulverbeschichtet  
Sicherheitsglas klar

**Schutzart:**  
IP65



**Lichtrichtung:**



**light technology:**  
230V Power LED  
2700K  
L70/50.000 h

reflector: flood

dimmable

**installation:**  
2x cable entry point;  
connection terminal  
3x 1,5 mm<sup>2</sup>

**material:**  
head: aluminium die-casting  
powder-coated  
bracket: stainless steel  
powder-coated  
safety glass clear

**protection class:**  
IP65



**light direction:**

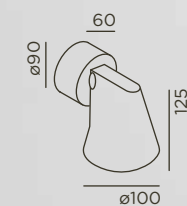

Größe in mm  
size in mm

Farbe colour	Art.-Nr. item no.	Systemleistung system performance
anthracite RAL 7016	91760-AN	8 W/559 lm
cool brown	91760-CB	8 W/559 lm
pure white RAL 9016	91760-WH	8 W/559 lm
deep black RAL 9005	91760-BL	8 W/559 lm

- + stic control . Seite page 196
- + stic ceiling . Seite page 214
- + stic ground . Seite page 306
- + stic spike . Seite page 310

Preise in separater Preisliste . prices in separate price list + [www.IP44.de](http://www.IP44.de)

stic control



wall

# stic control

Hier kommt Bewegung ins Spiel: ein ebenso präziser wie dezenter Bewegungsmelder aktiviert stic, wann immer Licht gebraucht und deaktiviert es, sobald es nicht mehr benötigt wird.

Motion-activated: a motion detector that is as precise as it is discreet activates stic when light is needed and deactivates it as soon as it is no longer required.



Dämmerungseinstellung zwischen 10-2000 Lux + Zeiteinstellung zwischen 5 Sek. und 8 Min. variabel einstellbar. Twilight setting between 10-2000 lux + time setting between 5 sec. and 8 min. variably adjustable.

Der Leuchtenkopf ist dreh- und schwenkbar. The luminaire head can be turned and swiveled.



## stic control Design: Klaus Nolting



<b>Lichttechnik:</b> 230V Power LED 2700K L70/50.000 h	<b>Material:</b> Aluminiumguss pulverbeschichtet Sicherheitsglas klar	<b>light technology:</b> 230V Power LED 2700K L70/50.000 h	<b>material:</b> aluminium die-casting powder-coated safety glass clear
<b>Reflektor:</b> Flood  <b>Erfassungswinkel 120°</b> Zeiteinstellung 5 Sek. - 8 Min. Dämmerungseinstellung 10-2000 Lux; Reichweite 9 m	<b>Schutzart:</b> IP44  	<b>reflector:</b> flood  <b>detection angle 120°</b> time setting 5 sec. - 8 min. twilight setting 10-2000 lux; range 9 m	<b>protection class:</b> IP44  
<b>Installation:</b> 2x Kabeleinführung; Anschlussklemme 4x 1,5 mm <sup>2</sup>	<b>Lichtrichtung:</b> 	<b>installation:</b> 2x cable entry point; connection terminal 4x 1,5 mm <sup>2</sup>	<b>light direction:</b> 

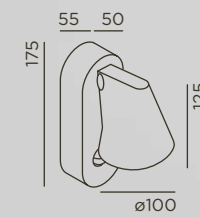

Größe in mm  
size in mm

Farbe colour	Art.-Nr. item no.	Systemleistung system performance
 anthracite RAL 7016	91761-AN	8 W/559 lm
 cool brown	91761-CB	8 W/559 lm
 pure white RAL 9016	91761-WH	8 W/559 lm
 deep black RAL 9005	91761-BL	8 W/559 lm

- + stic wall . Seite page 192
- + stic ceiling . Seite page 214
- + stic ground . Seite page 306
- + stic spike . Seite page 310

Preise in separater Preisliste . prices in separate price list + [www.IP44.de](http://www.IP44.de)

# ceiling

lisc	202
pro R	204
pro S	208
slat + slat one	210
stic	214
up R	218
up S	220

# lisc

Als klassisch reduzierte, superflache Deckenleuchte stellt lisc die perfekte Ergänzung zur Variante für die Wand dar. Die Wertigkeit der Leuchte wird durch das dickwandige, von innen opalweiße Glas betont.

As a classically reduced super-flat ceiling luminaire, lisc is a perfect supplement for the wall version. The high quality of the luminaire is emphasised by the thick-walled glass that is opal-white on the inside.



## lisc Design: Klaus Nolting

**Lichttechnik:**  
230V Power LED  
2700K  
L70/50.000 h

dimmbar

**Installation:**  
2x Kabeleinführung;  
Anschlussklemme  
3x 1,5 mm<sup>2</sup>

**Material:**  
Aluminiumguss  
pulverbeschichtet  
Kristallglas,  
innen opalweiß

**Schutzart:**  
IP65



**Lichtrichtung:**



light technology:  
230V Power LED  
2700K  
L70/50.000 h

dimmmable

**installation:**  
2x cable entry point;  
connection terminal  
3x 1,5 mm<sup>2</sup>

material:  
aluminium die-casting  
powder-coated  
crystal glass,  
opal-white inside

**protection class:**  
IP65



**light direction:**

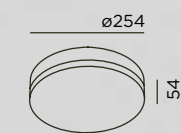

Größe in mm  
size in mm

**Farbe**  
colour

 anthracite  
RAL 7016

 pure white  
RAL 9016

**Art.-Nr.**  
item no.

91210-AN

91210-WH

**Systemleistung**  
system performance

14 W/815 lm

14 W/815 lm

+ lisc wall . Seite page 168

Preise in separater Preisliste . prices in separate price list + [www.IP44.de](http://www.IP44.de)

pro



ceiling

# pro R

Spot an! Unser Deckenstrahler pro R lässt sich flexibel und stufenlos neigen – so weit, bis jedes Objekt im vorteilhaftesten Licht erstrahlt.

Spotlight on! Our ceiling spotlight pro R tilts flexibly and variably until every object appears in the very best light.







Der klassische Zylinder wird zum schwenkbaren Strahler. Der nach innen versetzte Reflektor aus Reinstaluminium verleiht dem Aufbaustrahler Dynamik. The classic cylinder becomes a swivelling spotlight. The ultra-pure aluminium reflector is offset inwards to create a dynamic effect for the surface-mounted spotlight.



## pro R Design: IP44.DE

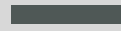
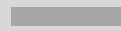

<b>Lichttechnik:</b> 230V Power LED 2700K L70/50.000 h	<b>Material:</b> Aluminiumguss pulverbeschichtet Sicherheitsglas klar	<b>light technology:</b> 230V Power LED 2700K L70/50.000 h	<b>material:</b> aluminium die-casting powder-coated safety glass clear
<b>Reflektor:</b> Flood  dimmbar	<b>Schutzart:</b> IP65  	<b>reflector:</b> flood  dimmable	<b>protection class:</b> IP65  
<b>Installation:</b> 2x Kabeleinführung; Anschlussklemme 3x 1,5 mm <sup>2</sup>	<b>Lichtrichtung:</b> 	<b>installation:</b> 2x cable entry point; connection terminal 3x 1,5 mm <sup>2</sup>	<b>light direction:</b> 
	<b>Farbe</b> colour	<b>Art.-Nr.</b> item no.	<b>Systemleistung</b> system performance
	 anthracite RAL 7016	91810-27-R-AN	15 W/1099 lm
	 space grey	91810-27-R-SG	15 W/1099 lm
	 pure white RAL 9016	91810-27-R-WH	15 W/1099 lm
	 deep black RAL 9005	91810-27-R-BL	15 W/1099 lm

Größe in mm  
size in mm

Preise in separater Preisliste . prices in separate price list + [www.IP44.de](http://www.IP44.de)



# pro S

Einerseits ist pro S eine ideale Deckenleuchte für den Außenbereich. Andererseits wirkt sie derart elegant, dass mancher sie auch innerhalb der eigenen vier Wände nicht missen mag. Fest steht: pro S erzeugt brillantes Licht und sorgt überall für eine gute Atmosphäre.

On the one hand pro S is a ceiling luminaire which is simply ideal for outside use. On the other hand it looks so elegant that some people even want to use it inside their own four walls. Whatever, pro S produces brilliant light and creates a good atmosphere all around.









Der formschöne Kubus wird zum schwenkbaren Strahler. Der nach innen versetzte Reflektor aus Reinstaluminium verleiht dem Aufbaustrahler Dynamik. The beautiful cube becomes a swivelling spotlight. The ultra-pure aluminium reflector is offset inwards to create a dynamic effect for the surface-mounted spotlight.



## pro S Design: IP44.DE

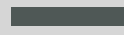
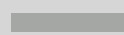

<b>Lichttechnik:</b> 230V Power LED 2700K L70/50.000 h	<b>Material:</b> Aluminiumguss pulverbeschichtet Sicherheitsglas klar	<b>light technology:</b> 230V Power LED 2700K L70/50.000 h	<b>material:</b> aluminium die-casting powder-coated safety glass clear
<b>Reflektor: Flood</b>  dimmbar	<b>Schutzart:</b> IP65 	<b>reflector: flood</b>  dimmable	<b>protection class:</b> IP65 
<b>Installation:</b> 2x Kabeleinführung; Anschlussklemme 3x 1,5 mm <sup>2</sup>	<b>Lichtrichtung:</b> 	<b>installation:</b> 2x cable entry point; connection terminal 3x 1,5 mm <sup>2</sup>	<b>light direction:</b> 
<b>Farbe</b> colour	<b>Art.-Nr.</b> item no.	<b>Systemleistung</b> system perform.	
 anthracite RAL 7016	91810-27-S-AN	15 W/1099 lm	
 space grey	91810-27-S-SG	15 W/1099 lm	
 pure white RAL 9016	91810-27-S-WH	15 W/1099 lm	
 deep black RAL 9005	91810-27-S-BL	15 W/1099 lm	

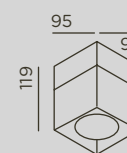

Größe in mm  
size in mm

Preise in separater Preisliste . prices in separate price list + [www.IP44.de](http://www.IP44.de)

slat + slat one

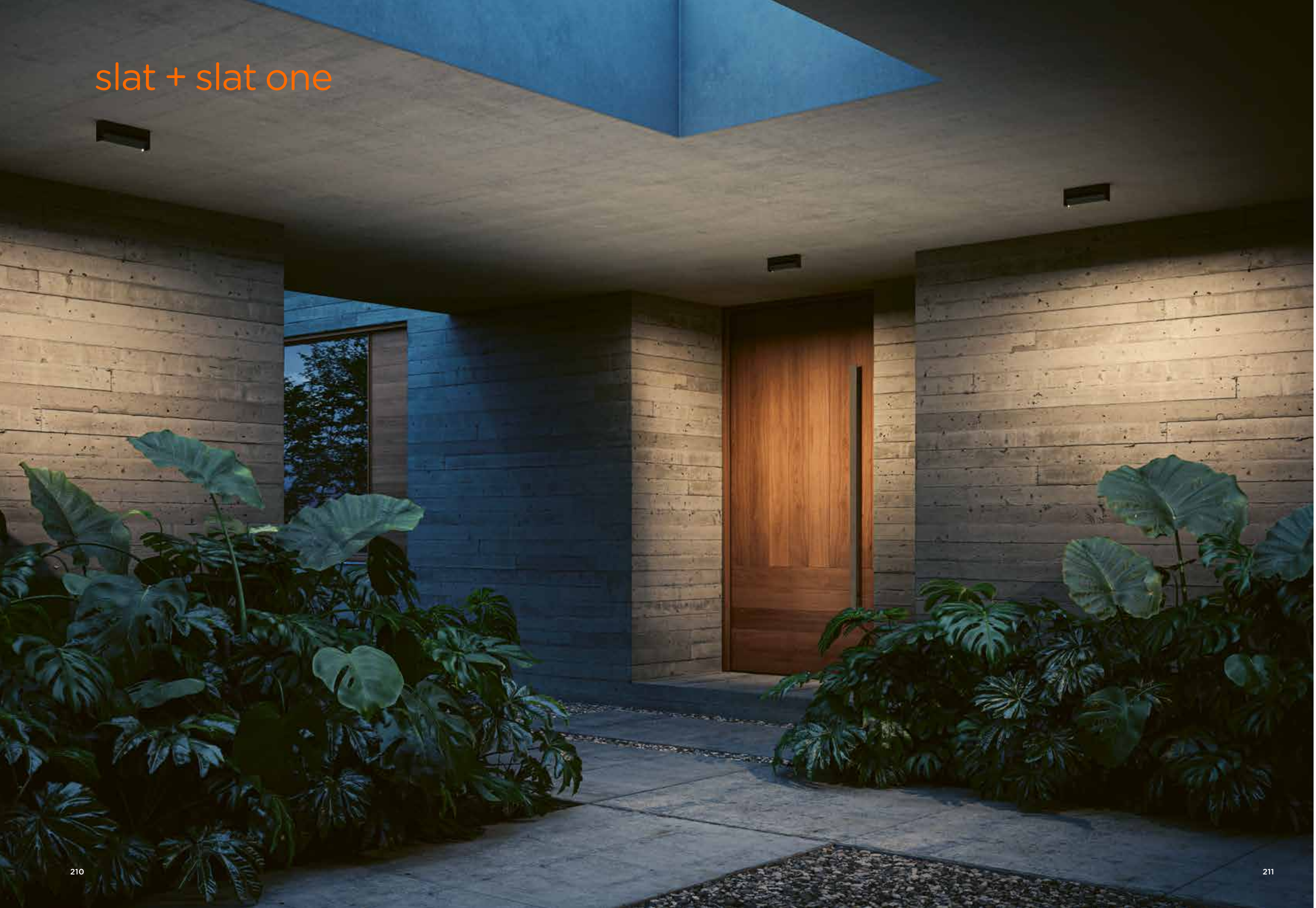

# slat + slat one

Alles Gute kommt bekanntlich von oben: slat + slat one bewegen sich nicht nur an der Wand, sie spenden auch als Deckenleuchten überaus brillantes Licht. Ihre um 240° drehbaren Lichtlamellen erzeugen ein wunderbar homogenes Licht.

All good things are known to come from above: slat + slat one move not just on the wall, they also generate quite brilliant light as ceiling luminaires. Its independently by 240° rotating light blades generate a wonderfully homogeneous light.



## slat + slat one Design: Klaus Nolting

**Lichttechnik:**  
230V Power LED  
2700K  
L70/50.000 h

dimmbar

**Installation:**  
slat: 2x Kabeleinführung;  
slat one: 1x Kabeleinführung;  
Anschlussklemme  
3x 1,5 mm<sup>2</sup>

**Material:**  
Aluminiumguss  
pulverbeschichtet  
Sicherheitsglas satiniert

**Schutzart:**  
IP65



**Lichtrichtung:**

**light technology:**  
230V Power LED  
2700K  
L70/50.000 h

dimmbare

**installation:**  
slat: 2x cable entry point;  
slat one: 1x cable entry point;  
connection terminal  
3x 1,5 mm<sup>2</sup>

**material:**  
aluminium die-casting  
powder-coated  
safety glass satined

**protection class:**  
IP65



**light direction:**

slat

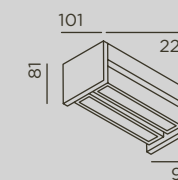

**Farbe**  
colour

**Art.-Nr.**  
item no.

**Systemleistung**  
system performance

	anthracite RAL 7016	91130-27-AN	16 W/675 lm
	cool brown	91130-27-CB	16 W/675 lm
	space grey	91130-27-SG	16 W/675 lm
	pure white RAL 9016	91130-27-WH	16 W/675 lm
	deep black RAL 9005	91130-27-BL	16 W/675 lm

slat one

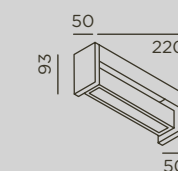

	anthracite RAL 7016	91131-27-AN	8 W/280 lm
	cool brown	91131-27-CB	8 W/280 lm
	space grey	91131-27-SG	8 W/280 lm
	pure white RAL 9016	91131-27-WH	8 W/280 lm
	deep black RAL 9005	91131-27-BL	8 W/280 lm

Größe in mm  
size in mm

- + slat wall . Seite page 184
- + slat one wall . Seite page 188
- + slat poller . Seite page 298
- + slat spike . Seite page 302

Preise in separater Preisliste . prices in separate price list + [www.IP44.de](http://www.IP44.de)



reddot award 2017  
winner



stic



ceiling

# stic

Wer Natur oder Architektur ins beste Licht setzen will, kommt um stic nicht herum. Bislang rein als Bodenstrahler im Einsatz, erhält sie jetzt Konsole und schwenkbares Gelenk für die Montage an Wand, Decke oder Boden - überall dort, wo ebenso brillantes wie fokussiertes Licht gebraucht wird.

If you want to put nature or architecture in the best light, you can't avoid stic. Designed originally as a pure ground spotlight, it has now been fitted with a bracket and swivel joint for mounting to the wall, ceiling or floor - wherever there is a need for both brilliant and focused light.



Der Leuchtenkopf ist dreh- und schwenkbar.  
The luminaire head can be turned and swiveled.



## stic Design: Klaus Nolting

**Lichttechnik:**  
230V Power LED  
2700K  
L70/50.000 h

**Reflektor:** Flood

dimmbar

**Installation:**  
2x Kabeleinführung;  
Anschlussklemme  
3x 1,5 mm<sup>2</sup>

**Material:**  
Kopf: Aluminiumguss  
pulverbeschichtet  
Konsole: Edelstahl  
pulverbeschichtet  
Sicherheitsglas klar

**Schutzart:**  
IP65



**Lichtrichtung:**

**light technology:**  
230V Power LED  
2700K  
L70/50.000 h

reflector: flood

dimmmable

**installation:**  
2x cable entry point;  
connection terminal  
3x 1,5 mm<sup>2</sup>

**material:**  
head: aluminium die-casting  
powder-coated  
bracket: stainless steel  
powder-coated  
safety glass clear

**protection class:**  
IP65



**light direction:**

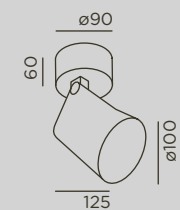

Größe in mm  
size in mm

Farbe colour	Art.-Nr. item no.	Systemleistung system performance
anthracite RAL 7016	91760-AN	8 W/559 lm
cool brown	91760-CB	8 W/559 lm
pure white RAL 9016	91760-WH	8 W/559 lm
deep black RAL 9005	91760-BL	8 W/559 lm

- + stic wall . Seite page 192
- + stic control . Seite page 196
- + stic ground . Seite page 306
- + stic spike . Seite page 310

Preise in separater Preisliste . prices in separate price list + [www.IP44.de](http://www.IP44.de)

# up R

Ein schlichter Zylinder, zuverlässige Technik, brillantes Licht:  
Mehr braucht eine Deckenleuchte nicht, um perfekt zu sein.  
up R, unser Downlight für elegante Außenbeleuchtung, die sich  
aufs Wesentliche konzentriert.

Simple cylinder, reliable technology, brilliant light: that's all a  
perfect ceiling luminaire needs. up R, our downlight for elegant  
outdoor lighting, focuses on what really matters.



## up R Design: IP44.DE

**Lichttechnik:**  
230V Power LED  
2700K  
L70/50.000 h

**Reflektor:** Flood  
dimmbar

**Installation:**  
2x Kabeleinführung;  
Anschlussklemme  
3x 1,5 mm<sup>2</sup>

**Material:**  
Aluminiumguss  
pulverbeschichtet  
Sicherheitsglas klar

**Schutzart:**  
IP65



**Lichtrichtung:**

**light technology:**  
230V Power LED  
2700K  
L70/50.000 h

**reflector:** flood  
dimmable

**installation:**  
2x cable entry point;  
connection terminal  
3x 1,5 mm<sup>2</sup>

**material:**  
aluminium die-casting  
powder-coated  
safety glass clear

**protection class:**  
IP65



**light direction:**



Größe in mm  
size in mm

Farbe colour	Art.-Nr. item no.	Systemleistung system performance
anthracite RAL 7016	91820-R-AN	15 W/978 lm
space grey	91820-R-SG	15 W/978 lm
pure white RAL 9016	91820-R-WH	15 W/978 lm
deep black RAL 9005	91820-R-BL	15 W/978 lm

Preise in separater Preisliste . prices in separate price list + [www.IP44.de](http://www.IP44.de)

# up S

up-solut funktional präsentiert sich unser jüngstes Downlight und ist daher die logische Wahl für alle Projekte, bei denen ebenso reduziertes wie zuverlässiges Außenlicht gefragt ist. Reflektor und Linse der schlichtweg eleganten up S fluten jeden Raum in breitem Winkel mit brilliantem Licht!

up-solutely functional is our latest downlight and therefore the ideal choice for all projects in need of both reduced and reliable outdoor lighting. Reflector and lens of the simply elegant up S flood every room with brilliant, wide-angled light!



## up S Design: IP44.DE

**Lichttechnik:**  
230V Power LED  
2700K  
L70/50.000 h

**Reflektor:** Flood  
dimmbar

**Installation:**  
2x Kabeleinführung;  
Anschlussklemme  
3x 1,5 mm<sup>2</sup>

**Material:**  
Aluminiumguss  
pulverbeschichtet  
Sicherheitsglas klar

**Schutzart:**  
IP65



**Lichtrichtung:**

**light technology:**  
230V Power LED  
2700K  
L70/50.000 h

**reflector:** flood  
dimmbare

**installation:**  
2x cable entry point;  
connection terminal  
3x 1,5 mm<sup>2</sup>

**material:**  
aluminium die-casting  
powder-coated  
safety glass clear

**protection class:**  
IP65



**light direction:**

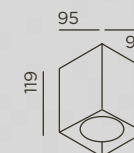

Größe in mm  
size in mm

Farbe colour	Art.-Nr. item no.	Systemleistung system performance
anthracite RAL 7016	91820-S-AN	15 W/978 lm
space grey	91820-S-SG	15 W/978 lm
pure white RAL 9016	91820-S-WH	15 W/978 lm
deep black RAL 9005	91820-S-BL	15 W/978 lm

Preise in separater Preisliste . prices in separate price list + [www.IP44.de](http://www.IP44.de)

# ground

	como poller	224
	cut poller	228
<i>NEW</i>	dia poller	232
	in A	238
	in S	240
	lin base	242
	lin poller	246
	lin spike	248
<i>NEW</i>	lix spike solar	252
	mir R poller	254
	mir X poller	258
	pad	262
	piek	268
	piek lettura	276
	piek mini solar	280
	pip poller	282
<i>NEW</i>	reed solar	284
	shot	286
	slat poller	298
	slat spike	302
	stic	306
	stic spike	310
	<b>jack</b>	316
	<b>ground Zubehör . accessory</b>	320



como poller



ground

# como poller

Schön eigenständig: Als Pollerleuchte bietet como poller tags wie nachts einen unverwechselbaren Anblick. Dank einer integrierten Glaslinse ist ihr Licht-Bild unverwechselbar fokussiert.

Nice and independent: the bollard luminaire is an aesthetic sight by day and night. An integrated glass lens produces an unmistakably focused lighting effect.



## como poller Design: IP44.DE



<b>Lichttechnik:</b> 230V Power LED 2700K L70/50.000 h  dimmbar  <b>Installation:</b> 2x Kabeleinführung; Anschlussklemme 3x 1,5 mm <sup>2</sup> ; Durchgangsverdrahtung mit Y-Verbinder in der Leuchte möglich  <b>Montage:</b> Bauseitiges Fundament oder befestigter Untergrund	<b>Material:</b> Aluminiumguss pulverbeschichtet Glaslinse  <b>Schutzart:</b> IP65    <b>Lichtrichtung:</b> 	<b>light technology:</b> 230V Power LED 2700K L70/50.000 h  dimmable  <b>installation:</b> 2x cable entry point; connection terminal 3x 1,5 mm <sup>2</sup> ; possibility of through wiring with Y-connector inside luminaire  <b>assembly:</b> on site foundation or solid ground	<b>material:</b> aluminium die-casting powder-coated glass lens  <b>protection class:</b> IP65    <b>light direction:</b> 
---	---	---	---

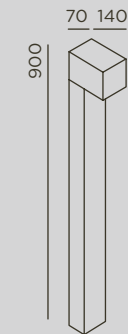

Größe in mm  
size in mm

+ como . Seite page 122  
+ como one . Seite page 126

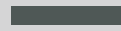
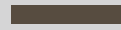
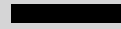
Farbe colour	Art.-Nr. item no.	Systemleistung system performance
 anthracite RAL 7016	92080-AN	6 W/276 lm
 cool brown	92080-CB	6 W/276 lm
 deep black RAL 9005	92080-BL	6 W/276 lm

Zubehör accessory	Artikel article	Art.-Nr. item no.
	Y-Verbinder Y-connector	55312
	Erdstück anchorage unit	55099

+ Nähere Informationen Seite 320  
further information page 320

Preise in separater Preisliste . prices in separate price list + [www.IP44.de](http://www.IP44.de)

cut poller



ground

# cut poller





Unsere schlicht-schöne Wandleuchte cut one verfügt jetzt über ein echtes Alleinstellungsmerkmal: In der Poller-Variante steht und leuchtet sie von ganz allein, wo auch immer in Garten oder Park, an Wegen oder Pfaden schönes Licht zuhause sein soll.

Our simple, attractive wall luminaire cut one now has a genuine unique selling point: in the bollard version it stands all on its own and illuminates the garden or park, ways or paths, wherever attractive light is wanted.





## cut poller Design: IP44.DE

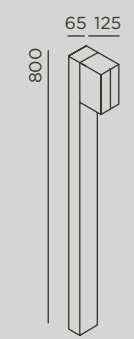

<b>Lichttechnik:</b> 230V Power LED 2700K L70/50.000 h	<b>Material:</b> Aluminiumguss pulverbeschichtet Sicherheitsglas klar	<b>light technology:</b> 230V Power LED 2700K L70/50.000 h	<b>material:</b> aluminium die-casting powder-coated safety glass clear
<b>Reflektor: Flood</b>  dimmbar	<b>Schutzart:</b> IP65	<b>reflector: flood</b>  dimmable	<b>protection class:</b> IP65
<b>Installation:</b> 1x Kabeleinführung; Anschlussklemme 3x 1,5 mm <sup>2</sup> ; Anschluss mehrerer Leuchten durch Sternverdrahtung mit externem Erd-Abzweigkasten möglich	 <b>Lichtrichtung:</b> 	<b>installation:</b> 1x cable entry point; connection terminal 3x 1,5 mm <sup>2</sup> ; possibility of connection of several luminaires by star wiring with external earth distribution box	 <b>light direction:</b> 
<b>Montage:</b> Bauseitiges Fundament oder befestigter Untergrund		<b>assembly:</b> on site foundation or solid ground	

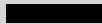

Größe in mm  
size in mm

Farbe colour	Art.-Nr. item no.	Systemleistung system performance
 anthracite RAL 7016	91045-AN	8 W/559 lm
 cool brown	91045-CB	8 W/559 lm
 deep black RAL 9005	91045-BL	8 W/559 lm

- + cut one . Seite page 134
- + cut . Seite page 128
- + cut control . Seite page 132

Zubehör accessory	Artikel article	Art.-Nr. item no.
	<b>Erd-Abzweigkasten</b> earth distribution box	55380
	<b>Erdstück</b> anchorage unit	55099

+ Nähere Informationen Seite 320  
further information page 320

Preise in separater Preisliste . prices in separate price list + [www.IP44.de](http://www.IP44.de)

dia poller

NEW

# dia poller

Wahrlich wegweisend: Unsere Reinterpretation einer klassischen Laterne steht auch als Pollerleuchte ihren Mann. An Auffahrt, Wegrand oder Parkplatz fällt ihre mehrfach designprämierte Kombination aus rauchfarbenem Glaskörper und profiliertem Acrylleuchtstab ins Auge.

Truly path-finding: our reinterpretation of a traditional lantern also stands its ground as a bollard luminaire. The eye-catching design that has won several awards combines a smoke-coloured glass body and profiled acrylic light rod, and is a creative feature when positioned at the drive, at the wayside or at the car park.

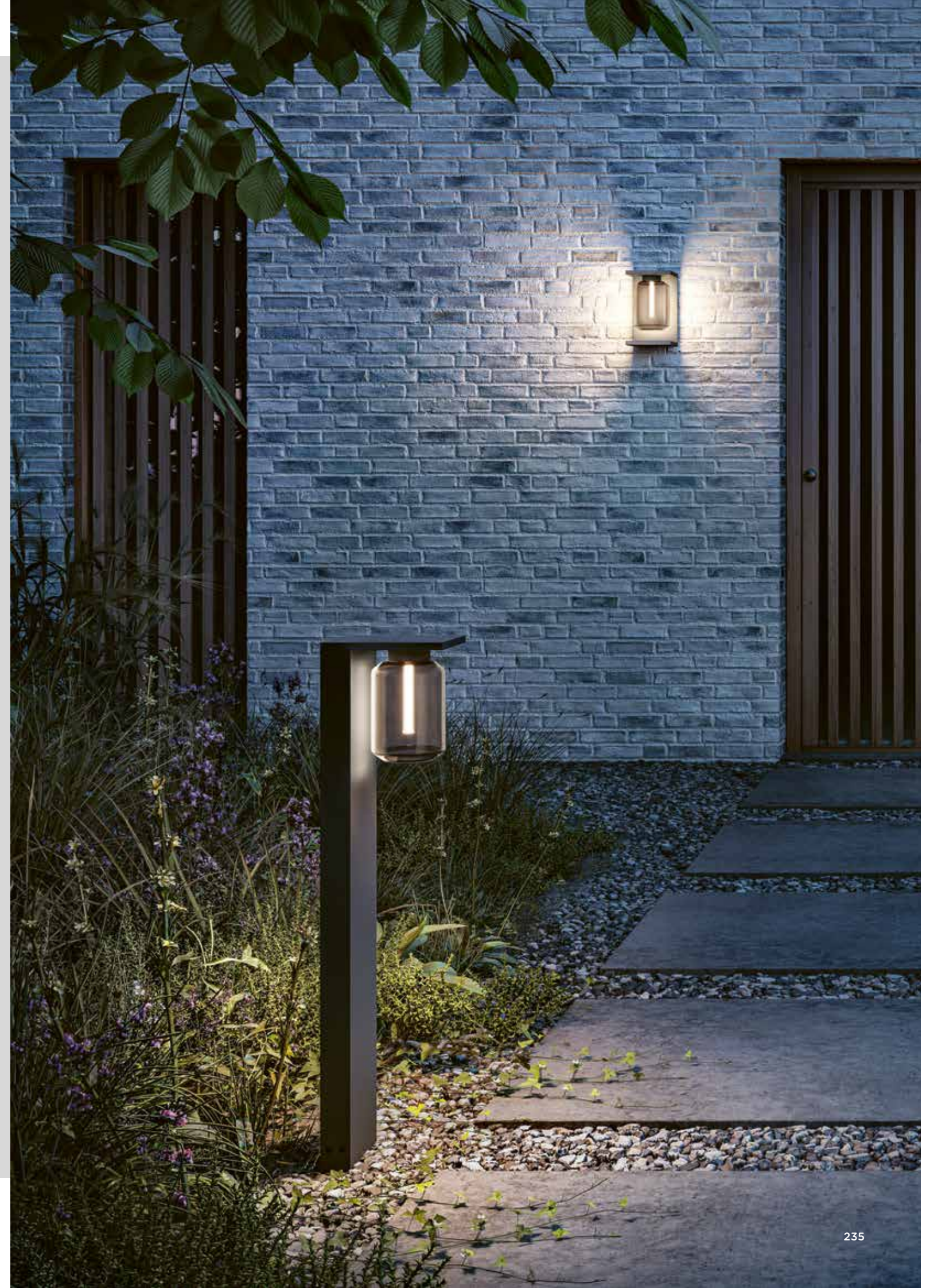



Der profilierte, reflektierende Leuchtstab scheint in dem rauchfarbenen Glas zu schweben.  
The profiled, reflecting acrylic rod seems to float in the smoke-coloured glass.

## dia poller Design: Sebastian David Büscher



**Lichttechnik:**  
230V Power LED  
2700K  
L70/50.000 h

dimmbar

**Installation:**  
2x Kabeleinführung;  
Anschlussklemme  
3x 1,5 mm<sup>2</sup>;  
Durchgangsverdrahtung mit  
Y-Verbinder in der Leuchte  
möglich

**Montage:**  
Bauseitiges Fundament oder  
befestigter Untergrund

**Material:**  
Aluminiumguss  
pulverbeschichtet  
rauchfarbenes Glas

**Schutzart:**  
IP65



**Lichtrichtung:**



light technology:  
230V Power LED  
2700K  
L70/50.000 h

dimmbable

installation:  
2x cable entry point;  
connection terminal  
3x 1,5 mm<sup>2</sup>  
possibility of through wiring  
with Y-connector  
inside luminaire

assembly:  
on site foundation or  
solid ground

material:  
aluminium die-casting  
powder-coated  
smoke-coloured glass

protection class:  
IP65



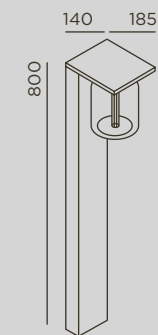

light direction:

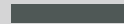

Größe in mm  
size in mm

+ dia . Seite page 138

Farbe colour	Art.-Nr. item no.	Systemleistung system performance
 anthracite RAL 7016	91050-AN	6 W/88 lm
 deep black RAL 9005	91050-BL	6 W/88 lm

Zubehör accessory	Artikel article	Art.-Nr. item no.
	Y-Verbinder Y-connector	55312
	Erdstück anchorage unit	55099

+ Nähere Informationen Seite 320  
further information page 320

Preise in separater Preisliste . prices in separate price list + [www.IP44.de](http://www.IP44.de)

# in A

Die asymmetrische Bodeneinbauleuchte besticht durch die präzise Verarbeitung des schwarz galvanisierten Edelstahlrahmens, der das flächenbündig eingelegte getönte Glas umfasst. Durch diese Kombination nimmt sie sich am Boden farblich zurück und setzt stattdessen Bäume und Sträucher in unbefestigten Untergründen ins rechte Licht. Die Variante mit Abdeckrahmen in stainless steel mit Klarglas erzeugt eine stärkere Dominanz der Leuchte.

The asymmetrical in-ground luminaire stands out with the precise workmanship of its black galvanized stainless steel frame that encompasses the tinted glass inserted flush with the surface. This combination of muted colours makes it almost imperceptible on the ground, where it lets trees and shrubs in unpaved areas appear in the right light instead. The version with stainless steel cover frame with clear glass gives the luminaire a more dominant role.



## in A . asymmetric Design: IP44.DE

für unbefestigte Beet- und Grünflächen for unpaved beds and greens

<b>Lichttechnik:</b> 230V Power LED 2700K L70/50.000 h  <b>Reflektor:</b> Flood asymmetrisch  dimmbar  <b>Installation:</b> 2 m Anschlussleitung (H05RN8-F 3G0,75 mm <sup>2</sup> ) mit Aquastop; Anschluss mehrerer Leuchten durch Sternverdrahtung mit externem Erd-Abzweigkasten möglich  trittfest	<b>Material:</b> Abdeckung: Edelstahl Glas: Sicherheitsglas Gehäuse: Polyamid, Glasfaser verstärkt  <b>Schutzart:</b> IP67    <b>Lichtrichtung:</b> 	light technology: 230V Power LED 2700K L70/50.000 h  reflector: flood asymmetric  dimmable  installation: 2 m connection cable (H05RN8-F 3G0,75 mm <sup>2</sup> ) with aquastop; possibility of connection of several luminaires by star wiring with external earth distribution box  walk-over resistant	material: cover ring: stainless steel glass: safety glass housing: polyamide, fibre glass reinforced  protection class: IP67    light direction: 
--	--	---	---

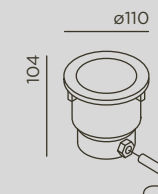

Größe in mm  
size in mm

Farbe colour	Art.-Nr. item no.	Systemleistung system performance
 stainless steel Sicherheits- glas klar safety glass clear	91081-27	8 W/ 539 lm
 stainless steel black galvanisiert Sicherheitsglas getönt galvanized safety glass tinted	91081-27-BL	8 W/238 lm

+ Anschluss optional mit IP44.DE connect. Produktdetails Seite 322  
connection with IP44.DE connect as an option. product details page 322

Zubehör accessory	Artikel article	Art.-Nr. item no.
	Erd-Abzweigkasten earth distribution box	55380

+ Nähere Informationen Seite 320  
further information page 320

Preise in separater Preisliste . prices in separate price list + [www.IP44.de](http://www.IP44.de)



# in S

Unsere symmetrische Bodeneinbauleuchte in S mit ausdrucksstarkem Edelstahlrahmen und flächenbündig eingelegtem Klarglas eignet sich wunderbar zur Inszenierung von Grünanlagen und Fassaden. Eine zurückhaltendere Variante ergibt sich durch die Kombination von schwarz galvanisiertem Abdeckrahmen mit getöntem Glas.

Our symmetric in-ground luminaire in S with expressive stainless steel frame and clear glass inserted flush with the surface is ideal for creating a wonderful setting for green spaces and facades. There is also a more restrained version with a black galvanized cover frame with tinted glass.



## in S . symmetric Design: IP44.DE

für unbefestigte Beet- und Grünflächen for unpaved beds and greens

**Lichttechnik:**  
230V Power LED  
2700K  
L70/50.000 h

**Reflektor:** Flood symmetrisch  
dimmbar

**Installation:**  
2 m Anschlussleitung  
(H05RN8-F 3G0,75 mm<sup>2</sup>)  
mit Aquastop;  
Anschluss mehrerer Leuchten  
durch Sternverdrahtung mit  
externem Erd-Abzweigkasten  
möglich

trittfest

**Material:**  
Abdeckung: Edelstahl  
Glas: Sicherheitsglas  
Gehäuse: Polyamid,  
Glasfaser verstärkt

**Schutzart:**  
IP67



**Lichtrichtung:**

**light technology:**  
230V Power LED  
2700K  
L70/50.000 h

**reflector:** flood symmetric  
dimmbare

**installation:**  
2 m connection cable  
(H05RN8-F 3G0,75 mm<sup>2</sup>)  
with aquastop;  
possibility of connection of  
several luminaires by star wiring  
with external earth distribution  
box

walk-over resistant

**material:**  
cover ring: stainless steel  
glass: safety glass  
housing: polyamide,  
fibre glass reinforced

**protection class:**  
IP67



**light direction:**



Größe in mm  
size in mm

Farbe colour	Art.-Nr. item no.	Systemleistung system performance
stainless steel Sicherheitsglas klar safety glass clear	91080-27	8 W/574 lm
stainless steel black galvanisiert Sicherheitsglas getönt galvanized safety glass tinted	91080-27-BL	8 W/261 lm

+ Anschluss optional mit IP44.DE connect. Produktdetails Seite 322  
connection with IP44.DE connect as an option. product details page 322

Zubehör accessory	Artikel article	Art.-Nr. item no.
	Erd-Abzweigkasten earth distribution box	55380

+ Nähere Informationen Seite 320  
further information page 320

Preise in separater Preisliste . prices in separate price list + [www.IP44.de](http://www.IP44.de)

lin



ground

# lin base

Auffälligstes Detail dieser wegweisenden Leuchte sind ihre Lamellen in einem formal reduzierten Leuchtenkörper. lin base mit Bodenplatte: die stabförmige Wegebeleuchtung sorgt immer für blendfreies, nach unten gerichtetes Licht.





The most eye-catching detail of this pioneering luminaire is its blades in a luminaire body with a minimalist design. lin base with base plate: this bar-shaped path lighting solution always provides glare-free downward-facing light.



lin base in den Höhen  
40 cm + 70 cm  
lin base in the heights  
40 cm + 70 cm

## lin base Design: IP44.DE

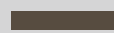
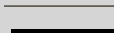

<b>Lichttechnik:</b> 230V Power LED 2700K L70/50.000 h  <b>dimmbar</b>  <b>Anschluss:</b> 5 m Zuleitung (H05RN-F 3G0,75 mm <sup>2</sup> ) inkl. Schutzkontaktstecker anschlussfertig  <b>Montage:</b> Bauseitiges Fundament oder befestigter Untergrund	<b>Material:</b> Aluminiumguss pulverbeschichtet Sicherheitsglas klar  <b>Schutzart:</b> IP65   <b>Lichtrichtung:</b> 	<b>light technology:</b> 230V Power LED 2700K L70/50.000 h  <b>dimmmable</b>  <b>connection:</b> 5 m supply cable (H05RN-F 3G0,75 mm <sup>2</sup> ) incl. safety plug ready to connect  <b>assembly:</b> on site foundation or solid ground	<b>material:</b> aluminium die-casting powder-coated safety glass clear  <b>protection class:</b> IP65   <b>light direction:</b> 
--	--	--	---

lin 40 base	Farbe colour	Art.-Nr. item no.	Systemleistung system performance
	 anthracite RAL 7016	92093-27-AN	9 W/164 lm
	 cool brown	92093-27-CB	9 W/164 lm
	 deep black RAL 9005	92093-27-BL	9 W/164 lm
	 anthracite RAL 7016	92090-27-AN	18 W/328 lm
	 cool brown	92090-27-CB	18 W/328 lm
	 deep black RAL 9005	92090-27-BL	18 W/328 lm

Größe in mm  
size in mm

+ Optional mit CH-Stecker . Art.-Nr. + Preise in separater Preisliste + [www.IP44.de](http://www.IP44.de)  
with CH-plug as an option . item no. + prices in separate price list + [www.IP44.de](http://www.IP44.de)

+ Anschluss optional mit IP44.DE connect. Produktdetails Seite 322  
connection with IP44.DE connect as an option. product details page 322

+ lin poller . Seite page 246  
+ lin spike . Seite page 248

Preise in separater Preisliste . prices in separate price list + [www.IP44.de](http://www.IP44.de)

# lin poller

Schon sehr erfolgreich als ortsveränderliche Wegeleuchte, lässt sich die lin poller jetzt unauffällig per lin box anschließen und wird so zur klassischen Pollerleuchte. Die elegante Optik, mit stabförmigem Leuchtkörper und innenliegenden Lamellen bleibt unverändert.

Already a highly successful movable path luminaire, lin poller can now be turned into a classic poller luminaire by connecting it unobtrusively with the lin box. The elegant look with bar-shaped luminaire body and inner blades remains unchanged.



lin poller in den Höhen  
40 cm + 70 cm  
lin poller in the heights  
40 cm + 70 cm



## lin poller Design: IP44.DE

**Lichttechnik:**  
230V Power LED  
2700K  
L70/50.000 h

**dimmbar**

**Installation:**  
Durchgangsverdrahtung  
möglich

**Montage:**  
Bauseitiges Fundament oder  
befestigter Untergrund

**Material:**  
Aluminiumguss  
pulverbeschichtet  
Sicherheitsglas klar

**Schutzart:**  
IP65



**Lichtrichtung:**

**light technology:**  
230V Power LED  
2700K  
L70/50.000 h

**dimmbare**

**installation:**  
possibility of through  
wiring

**assembly:**  
on site foundation or  
solid ground

**material:**  
aluminium die-casting  
powder-coated  
safety glass clear

**protection class:**  
IP65



**light direction:**

### lin 40 poller

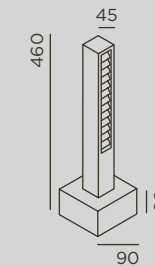

**Farbe**  
colour

**Art.-Nr.**  
item no.

**Systemleistung**  
system perform.

anthracite  
RAL 7016

92095-27-AN

9 W/164 lm

cool brown

92095-27-CB

9 W/164 lm

deep black  
RAL 9005

92095-27-BL

9 W/164 lm

### lin 70 poller

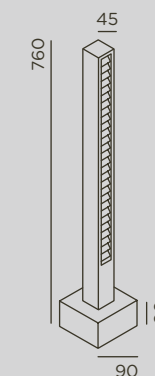

anthracite  
RAL 7016

92092-27-AN

18 W/328 lm

cool brown

92092-27-CB

18 W/328 lm

deep black  
RAL 9005

92092-27-BL

18 W/328 lm

Größe in mm  
size in mm

+ lin base . Seite page 242  
+ lin spike . Seite page 248

**Zubehör**  
accessory

**Artikel**  
article

**Art.-Nr.**  
item no.

**Erdstück**  
anchorage unit

55099

+ Nähere Informationen Seite 320  
further information page 320

Preise in separater Preisliste . prices in separate price list + [www.IP44.de](http://www.IP44.de)

lin



ground

# lin spike

Auffälligstes Detail dieser wegweisenden Leuchte sind ihre Lamellen in einem formal reduzierten Leuchtenkörper. Die ortsveränderliche lin spike mit Bodenspieß sorgt als stabförmige Wegebeleuchtung immer für blendfreies, nach unten gerichtetes Licht.

The most eye-catching detail of this pioneering luminaire is its blades in a luminaire body with a minimalist design. lin spike, the movable luminaire with a ground spike always provides glare-free-downward-facing light as bar-shaped path lighting solution.













lin spike in den Höhen  
40 cm + 70 cm  
lin spike in the heights  
40 cm + 70 cm

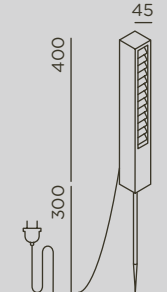

## lin spike Design: IP44.DE

für unbefestigte Beet- und Grünflächen for unpaved beds and greens

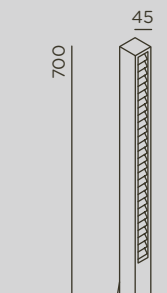
<b>Lichttechnik:</b> 230V Power LED 2700K L70/50.000 h  <b>dimmbar</b>  <b>Anschluss:</b> 5 m Zuleitung (H05RN-F 3G0,75 mm <sup>2</sup> ) inkl. Schutzkontaktstecker anschlussfertig  <b>ortsveränderlich</b>	<b>Material:</b> <b>Kopf + Lamellen:</b> Aluminiumguss pulverbeschichtet <b>Spieß: Edelstahl</b> pulverbeschichtet Sicherheitsglas klar  <b>Schutzart:</b> IP65   <b>Lichtrichtung:</b> 	<b>light technology:</b> 230V Power LED 2700K L70/50.000 h  <b>dimmable</b>  <b>connection:</b> 5 m supply cable (H05RN-F 3G0,75 mm <sup>2</sup> ) incl. safety plug ready to connect  <b>movable</b>	<b>material:</b> head + slats: aluminium die-casting powder-coated spike: stainless steel powder-coated safety glass clear  <b>protection class:</b> IP65   <b>light direction:</b> 
--	---	--	---

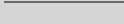
lin 40 spike	Farbe colour	Art.-Nr. item no.	Systemleistung system performance
	 anthracite RAL 7016	92094-27-AN	9 W/164 lm
	 cool brown	92094-27-CB	9 W/164 lm
	 deep black RAL 9005	92094-27-BL	9 W/164 lm
lin 70 spike			
	 anthracite RAL 7016	92091-27-AN	18 W/328 lm
	 cool brown	92091-27-CB	18 W/328 lm
	 deep black RAL 9005	92091-27-BL	18 W/328 lm

Größe in mm  
size in mm

+ Optional mit CH-Stecker . Art.-Nr. + Preise in separater Preisliste + [www.IP44.de](http://www.IP44.de)  
with CH-plug as an option . item no. + prices in separate price list + [www.IP44.de](http://www.IP44.de)

+ Anschluss optional mit IP44.DE connect. Produktdetails Seite 322  
connection with IP44.DE connect as an option. product details page 322

+ lin poller . Seite page 246  
+ lin base . Seite page 242

Preise in separater Preisliste . prices in separate price list + [www.IP44.de](http://www.IP44.de)

# lix spike solar

Die schlanke Schwester unseres portablen Bestsellers lix. Und genau wie diese ein Lieferant blendfreien, flächigen Rundumlichts, das atmosphärische Lichtinseln schafft. Die lix spike solar wird mit ihrem eigenen Solar- und Speichermodul versorgt und ist dadurch absolut autark.

The slender sister of our portable bestseller lix. And in just the same way, lix spike solar provides glare-free wide-area all-round light, creating atmospheric light islands. This luminaire is supplied with power by its own solar and storage module, so that it is absolutely self-sufficient.



NEW

Die Leuchte aktiviert sich bei Einbruch der Dunkelheit über die automatische Dämmerungsfunktion. The luminaire switches on when it starts to get dark thanks to the automatic twilight function.

SOLAR

Die lix spike solar benötigt weder Stromanschluss noch festen Untergrund. Sehr autark also. Dank des Solarpanels ist sie ihr eigener Energieversorger! lix spike solar requires neither a power outlet nor a solid surface. That makes it very self-sufficient. The solar panel supplies all the energy it needs.



## lix spike solar Design: Klaus Nolting

für unbefestigte Beet- und Grünflächen for unpaved beds and greens

**Lichttechnik:**  
LED  
Lithium-Ionen Akku  
1x 2600 mAh  
2700K  
solar panel S

**Anschluss:**  
0,8 m Zuleitung Leuchte  
(H05RN8-F 2x0,75 mm<sup>2</sup>)  
+ 1 m Zuleitung Solarpanel  
(H05RN8-F 2x0,75 mm<sup>2</sup>)

ortsveränderlich

**Material:**  
Leuchte: Aluminiumguss pulverbeschichtet  
+ Polycarbonat matt  
Solarpanel: Kopf: Aluminiumguss pulverbeschichtet;  
Stab: Edelstahl pulverbeschichtet; Klarglas

**Schutzart:**  
IP65



**Lichtrichtung:**



**light technology:**  
LED  
lithium-ion battery  
1x 2600 mAh  
2700K  
solar panel S

**connection:**  
0,8 m supply cable luminaire  
(H05RN8-F 2x0,75 mm<sup>2</sup>)  
+ 1 m supply cable solar panel  
(H05RN8-F 2x0,75 mm<sup>2</sup>)

movable

**material:**  
luminaire: aluminium die-casting powder-coated  
+ polycarbonate matt  
solar panel: head: aluminium-die-casting powder-coated;  
pole: stainless steel powder-coated; clear glass

**protection class:**  
IP65



**light direction:**

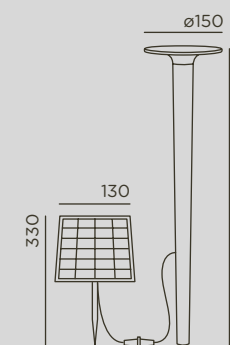

Größe in mm  
size in mm

**Farbe**  
colour

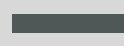
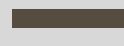
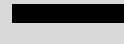
-  anthracite  
RAL 7016
-  cool brown
-  deep black  
RAL 9005

**Art.-Nr.**  
item no.

- 93093-AN
- 93093-CB
- 93093-BL

**Systemleistung**  
system performance

- 1,1 W/65 lm
- 1,1 W/65 lm
- 1,1 W/65 lm

+ Anschluss optional mit IP44.DE solar join . Produktdetails Seite 348  
connection with IP44.DE solar join as an option . product details page 348

+ lix . Seite page 82

Preise in separater Preisliste . prices in separate price list + [www.IP44.de](http://www.IP44.de)

mir R poller



ground



# mir R poller

Der Poller mir R bettet sich mit seinem flachen, runden Kopf auf wunderbare Weise in die Umgebung ein. Die Leuchte erzeugt durch die vier im Kopf verarbeiteten Power-LEDs eine absolut blendfreie 360° Beleuchtung des Bodens.





The bollard mir R with its flat round head blends perfectly into the environment: with the four power LEDs integrated in the head, the luminaire produces absolutely glare-free 360° illumination on the ground.







mir R poller in den Höhen  
30 cm + 70 cm  
mir R poller in the heights  
30 cm + 70 cm

## mir R poller Design: Klaus Nolting

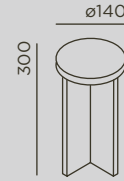

<b>Lichttechnik:</b> 230V Power LED 2700K L70/50.000 h  <b>dimmbar</b>  <b>Installation:</b> 1x Kabeleinführung; Anschlussklemme 3x 1,5 mm²; Anschluss mehrerer Leuchten durch Sternverdrahtung mit externem Erd-Abzweigkasten möglich  <b>Montage:</b> Bauseitiges Fundament oder befestigter Untergrund	<b>Material:</b> Aluminiumguss pulverbeschichtet  <b>Schutzart:</b> IP65    <b>Lichtstrahlung:</b> 	<b>light technology:</b> 230V Power LED 2700K L70/50.000 h  <b>dimmbare</b>  <b>installation:</b> 1x cable entry point; connection terminal 3x 1,5 mm²; possibility of connection of several luminaires by star wiring with external earth distribution box  <b>assembly:</b> on site foundation or solid ground	<b>material:</b> aluminium die-casting powder-coated  <b>protection class:</b> IP65    <b>light direction:</b> 
---	---	--	---

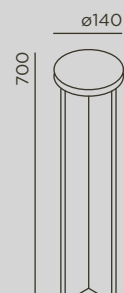
mir R 30 poller	Farbe colour	Art.-Nr. item no.	Systemleistung system performance
	 anthracite RAL 7016	91005-27-AN	12 W/209 lm
	 cool brown	91005-27-CB	12 W/209 lm

	 anthracite RAL 7016	91006-27-AN	12 W/209 lm
	 cool brown	91006-27-CB	12 W/209 lm

Größe in mm  
size in mm

Zubehör accessory	Artikel article	Art.-Nr. item no.
	Erd-Abzweigkasten earth distribution box	55380
	Erdstück anchorage unit	55099

+ Nähere Informationen Seite 320  
further information page 320

Preise in separater Preisliste . prices in separate price list + [www.IP44.de](http://www.IP44.de)

mir X poller



ground

# mir X poller

Die Pollerleuchte mir X ist ein klares architektonisches Statement. Die Leuchte erzeugt durch die vier im Kopf verarbeiteten Power-LEDs eine absolut blendfreie 360° Beleuchtung des Bodens.

The bollard mir X makes a clear architectural statement: with the four power LEDs integrated in the head, the luminaire produces absolutely glare-free 360° illumination on the ground.



mir X poller in den Höhen  
30 cm + 70 cm  
mir X poller in the heights  
30 cm + 70 cm



## mir X poller Design: Klaus Nolting

**Lichttechnik:**  
230V Power LED  
2700K  
L70/50.000 h

dimmbar

**Installation:**  
1x Kabeleinführung;  
Anschlussklemme  
3x 1,5 mm<sup>2</sup>;  
Anschluss mehrerer Leuchten  
durch Sternverdrahtung mit  
externem Erd-Abzweigkasten  
möglich

**Montage:**  
Bauseitiges Fundament oder  
befestigter Untergrund

**Material:**  
Aluminiumguss  
pulverbeschichtet

**Schutzart:**  
IP65



**Lichtstrahlung:**



light technology:  
230V Power LED  
2700K  
L70/50.000 h

dimmable

**installation:**  
1x cable entry point;  
connection terminal  
3x 1,5 mm<sup>2</sup>;  
possibility of connection of  
several luminaires by star wiring  
with external earth distribution  
box

**assembly:**  
on site foundation or  
solid ground

material:  
aluminium die-casting  
powder-coated

protection class:  
IP65



light direction:



mir X 30 poller	Farbe colour	Art.-Nr. item no.	Systemleistung system performance
	anthracite RAL 7016	91001-27-AN	12 W/209 lm
	cool brown	91001-27-CB	12 W/209 lm

	anthracite RAL 7016	91002-27-AN	12 W/209 lm
	cool brown	91002-27-CB	12 W/209 lm

Größe in mm  
size in mm

Zubehör accessory	Artikel article	Art.-Nr. item no.
	Erd-Abzweigkasten earth distribution box	55380
	Erdstück anchorage unit	55099

+ Nähere Informationen Seite 320  
further information page 320

Preise in separater Preisliste . prices in separate price list + [www.IP44.de](http://www.IP44.de)

pad



ground

# pad

pad weckt viele Assoziationen. Vor allem aber spendet sie ein beruhigend homogenes flächiges Licht nach unten. Die ortsveränderliche Bodenspießleuchte mit verstellbarem Kopf setzt einzigartige Akzente in unbefestigten Beet- und Grünanlagen, erhellt aber genauso gut Gehwege.

pad evokes many associations. Its main quality is providing downward-facing wide-area light that is both calming and homogeneous. The movable luminaire with a ground spike features an adjustable head and not only creates unique highlights in flowerbeds and lawns but can also light up paths.

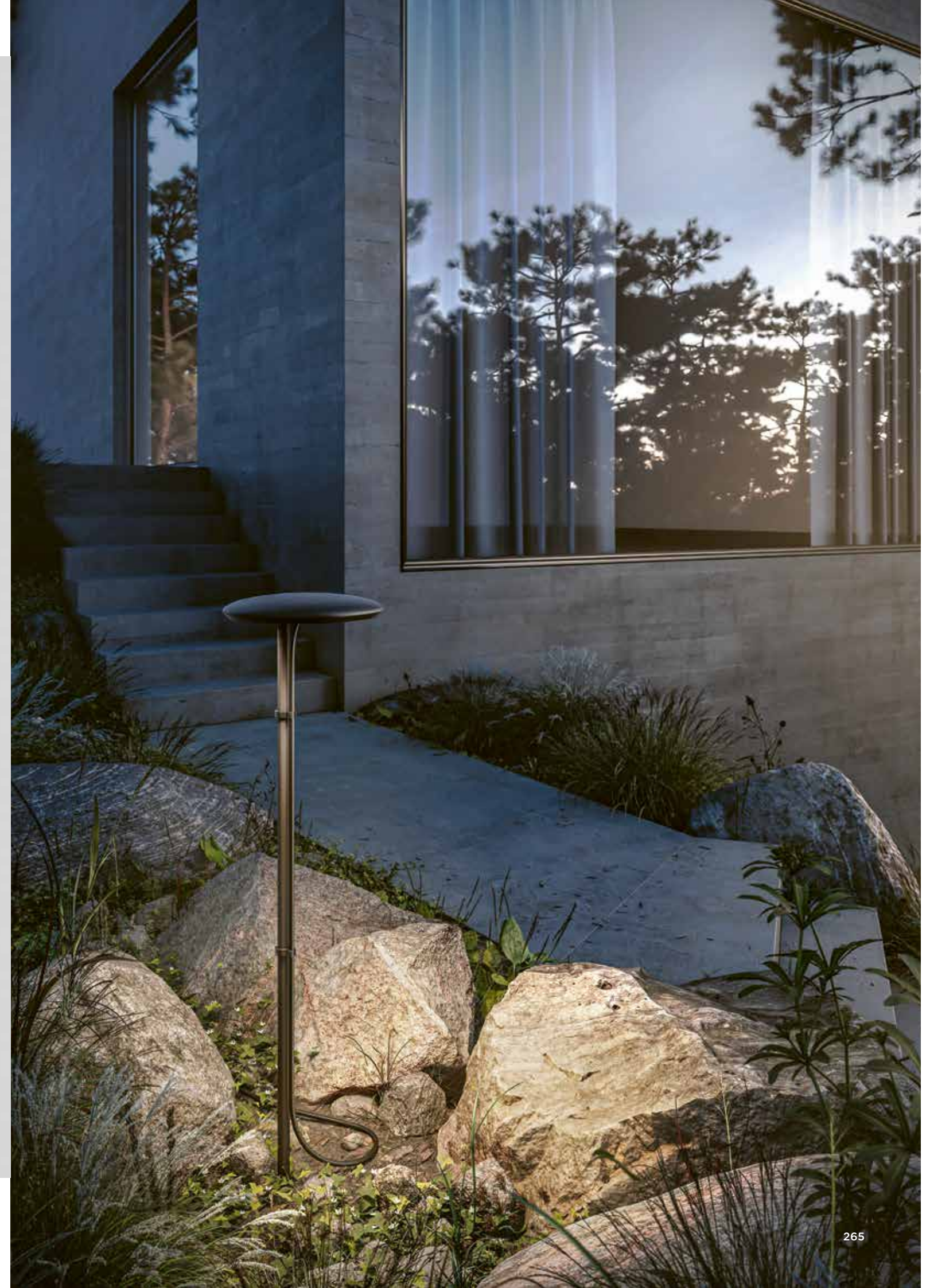





45°





**pad** Design: Sebastian David Büscher

für unbefestigte Beet- und Grünflächen for unpaved beds and greens

**Lichttechnik:**  
230V Power LED  
2700K  
L70/50.000 h  
**dimmbar**  
**Anschluss:**  
5 m Zuleitung  
(H05RN8-F 3G0,75 mm<sup>2</sup>)  
inkl. Schutzkontaktstecker  
anschlussfertig  
**ortsveränderlich**

**Material:**  
**Kopf:** Aluminiumguss  
pulverbeschichtet  
**Stab:** Edelstahl  
pulverbeschichtet  
Prismatikglas Acryl  
**Schutzart:**  
IP65  
  
**Lichtrichtung:**  

**light technology:**  
230V Power LED  
2700K  
L70/50.000 h  
**dimmbable**  
**connection:**  
5 m supply cable  
(H05RN8-F 3G0,75 mm<sup>2</sup>)  
incl. safety plug  
ready to connect  
**movable**

**material:**  
head: aluminium die-casting  
powder-coated  
pole: stainless steel  
powder-coated  
prismatic glass acryl  
**protection class:**  
IP65  
  
**light direction:**  

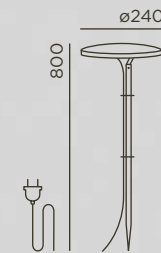

Größe in mm  
size in mm

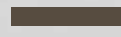
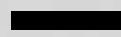
Farbe colour	Art.-Nr. item no.	Systemleistung system performance
 anthracite RAL 7016	91065-27-AN	8 W/553 lm
 cool brown	91065-27-CB	8 W/553 lm
 deep black RAL 9005	91065-27-BL	8 W/553 lm

+ Optional mit CH-Stecker . Art.-Nr. + Preise in separater Preisliste + [www.IP44.de](http://www.IP44.de)  
with CH-plug as an option . item no. + prices in separate price list + [www.IP44.de](http://www.IP44.de)

+ Anschluss optional mit IP44.DE connect. Produktdetails Seite 322  
connection with IP44.DE connect as an option. product details page 322

Preise in separater Preisliste . prices in separate price list + [www.IP44.de](http://www.IP44.de)

piek



ground

# piek

Manche Außenleuchten geben ein gutes Licht. Andere geben vor allem ein gutes Bild ab. Unser mehrfach prämierter Bodenstrahler piek in drei verschiedenen Höhen bildet die perfekte Symbiose von beidem: Nachts eine zuverlässige Lichtquelle, ist er bei Tage ein echter Hingucker.

Some outside luminaires produce good light. Others are above all pleasing to look at. Our ground spotlight piek in three different heights, which has won several design awards offers a perfect symbiosis of both: at night it acts as a reliable source, while being a real eye-catcher during the day.



piek in den Höhen  
25 cm + 50 cm + 100 cm  
piek in the heights  
25 cm + 50 cm + 100 cm



product  
design  
award  
2010



reddot design award  
winner 2009



Designpreis  
deutschland  
2011  
NOMINIERT



# piek cover

Das piek cover lässt sich optional mit wenigen Handgriffen auf dem Leuchtenkopf der piek positionieren. Das piek cover L dient als optische Linse für den perfekten Fokus. Mit dem piek cover S bekommt die Leuchte ganz einfach einen neuen Look. Das piek cover C mit Wabenoptik sorgt darüber hinaus für absolut blendfreies Licht.

The piek cover is an optional extra that can be easily positioned on the luminaire head of the piek in just a few simple steps. The piek cover L serves as optical lens for the perfect focus. piek cover S is a simple solution to give the luminaire a whole new look, while the piek cover C features a honeycomb design for completely glare-free light.



piek cover L

Für alle, die ein Objekt ins rechte Licht rücken wollen, ist piek cover L die praktische Erweiterung. Als optische Linse wird sie einfach auf piek's Leuchtenkopf aufgeschoben. Durch stufenloses Verschieben lässt sich vom Flood- bis zum Spotlight genau der gewünschte Fokus wählen. piek cover L is the practical addition for all those wanting to put something in its true light. The cover lens simply slides over piek's luminaire head. Fully variable positioning allows for precise adjustment of the desired focus, from floodlight to spotlight.



piek cover C



piek cover S



für unbefestigte Beet- und Grünflächen for unpaved beds and greens

<b>Lichttechnik:</b> 230V Power LED 2700K L70/50.000 h  <b>Reflektor: Flood</b>  <b>dimmbar</b>  <b>Anschluss:</b> 5 m Zuleitung (H05RN8-F 3G0,75 mm <sup>2</sup> ) inkl. Schutzkontaktstecker anschlussfertig  ortsveränderlich	<b>Material:</b> Kopf: Aluminiumguss pulverbeschichtet Stab: Edelstahl pulverbeschichtet Klarglas  <b>Schutzart:</b> IP65  <b>Lichtrichtung:</b> 	<b>light technology:</b> 230V Power LED 2700K L70/50.000 h  <b>reflector: flood</b>  <b>dimmmable</b>  <b>connection:</b> 5 m supply cable (H05RN8-F 3G0,75 mm <sup>2</sup> ) incl. safety plug ready to connect  movable	<b>material:</b> head: aluminium die-casting powder-coated pole: stainless steel powder-coated clear glass  <b>protection class:</b> IP65  <b>light direction:</b> 
---	--	--	--

piek 25	Farbe colour	Art.-Nr. item no.	Systemleistung system performance
	anthracite RAL 7016	92071-27-AN	6 W/220 lm
	cool brown	92071-27-CB	6 W/220 lm
	deep black RAL 9005	92071-27-BL	6 W/220 lm

piek 50	Farbe colour	Art.-Nr. item no.	Systemleistung system performance
	anthracite RAL 7016	92070-27-AN	6 W/220 lm
	cool brown	92070-27-CB	6 W/220 lm
	deep black RAL 9005	92070-27-BL	6 W/220 lm

piek 100	Farbe colour	Art.-Nr. item no.	Systemleistung system performance
	anthracite RAL 7016	92072-27-AN	6 W/220 lm
	cool brown	92072-27-CB	6 W/220 lm
	deep black RAL 9005	92072-27-BL	6 W/220 lm

Größe in mm  
size in mm

+ Optional mit CH-Stecker . Art.-Nr. + Preise in separater Preisliste + [www.IP44.de](http://www.IP44.de)  
with CH-plug as an option . item no. + prices in separate price list + [www.IP44.de](http://www.IP44.de)

+ Anschluss optional mit IP44.DE connect. Produktdetails Seite 322  
connection with IP44.DE connect as an option. product details page 322

+ piek lettura . Seite page 276  
+ piek mini solar . Seite page 280

Preise in separater Preisliste . prices in separate price list + [www.IP44.de](http://www.IP44.de)



piek cover L  
Stufenlos vom Flood- zum Spotlight. Variable adjustment from flood-light to spotlight.

Zubehör accessory

piek cover



piek cover S	Farbe colour	Art.-Nr. item no.	Material material
	anthracite RAL 7016	92074-CS-AN	Aluminiumguss pulverbeschichtet aluminium die-casting powder-coated
	cool brown	92074-CS-CB	Aluminiumguss pulverbeschichtet aluminium die-casting powder-coated
	deep black RAL 9005	92074-CS-BL	Aluminiumguss pulverbeschichtet aluminium die-casting powder-coated
	anthracite RAL 7016	92074-CC-AN	Aluminiumguss pulverbeschichtet aluminium die-casting powder-coated
	cool brown	92074-CC-CB	Aluminiumguss pulverbeschichtet aluminium die-casting powder-coated
	deep black RAL 9005	92074-CC-BL	Aluminiumguss pulverbeschichtet aluminium die-casting powder-coated
	anthracite RAL 7016	92074-CL-AN	Aluminiumguss pulverbeschichtet aluminium die-casting powder-coated
	cool brown	92074-CL-CB	Aluminiumguss pulverbeschichtet aluminium die-casting powder-coated
	deep black RAL 9005	92074-CL-BL	Aluminiumguss pulverbeschichtet aluminium die-casting powder-coated

Größe in mm  
size in mm

Preise in separater Preisliste . prices in separate price list + [www.IP44.de](http://www.IP44.de)

piek lettura



# piek lettura

Ein Sommerabend auf der Terrasse mit einem guten Buch: unsere neue Stehleuchte piek lettura bildet dafür die perfekte Lichtquelle! Mit ihrem stabilen Fuß verliert sie nie die Bodenhaftung und durch unterschiedliche Neigungswinkel und den stufenlos verstellbaren Kopf stellt sie sich flexibel auf jede Situation ein! Unseren klassischen Bodenstrahler piek ergänzt sie dabei aufs Beste.

Our new piek lettura floor luminaire is the perfect source of light for a summer evening out on the terrace with a good book! With its stable base, it always stays firmly on the ground, while its different tilt angles and fully adjustable head enable it to flexibly adjust to suit every situation! It is the ideal luminaire to complement our classic ground spotlight piek.

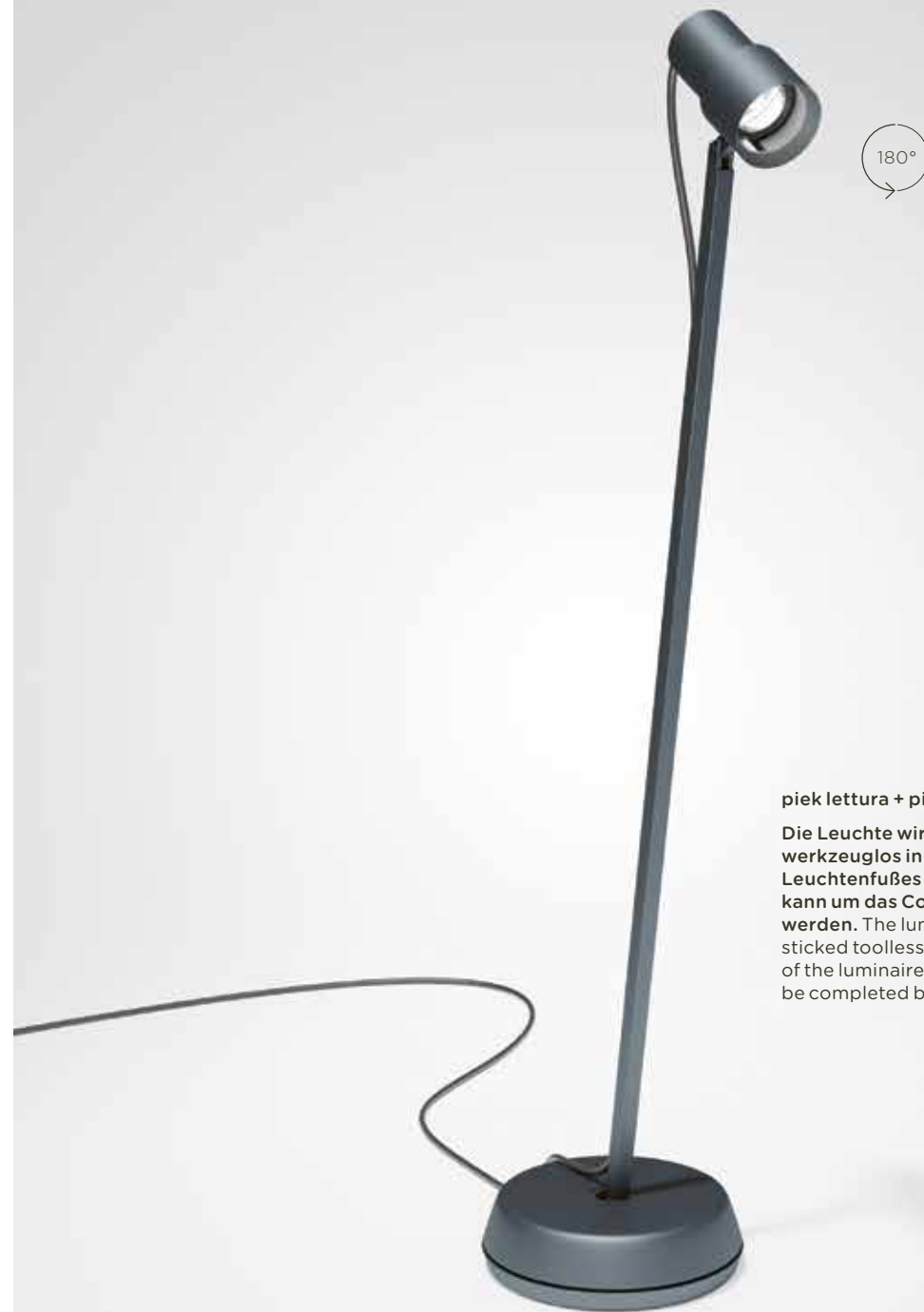

### piek lettura + piek cover S

Die Leuchte wird ganz einfach werkzeuglos in den Konus des Leuchtenfußes gesteckt und kann um das Cover ergänzt werden. The luminaire is easily stuck into the cone of the luminaire base and can be completed by the cover.

## piek lettura + piek lettura controller Design: Sebastian David Büscher



**Lichttechnik:**  
230V Power LED  
2700K  
L70/50.000 h

**Reflektor:** Flood

**dimmbar**

**Anschluss:**  
5 m Zuleitung  
(H05RN8-F 3G0,75 mm<sup>2</sup>)  
inkl. Schutzkontaktstecker  
anschlussfertig

[piek lettura controller:  
inkl. Controller]

ortsveränderlich

**Material:**  
Kopf: Aluminiumguss  
pulverbeschichtet  
Stab: Edelstahl  
pulverbeschichtet  
Fuß: Eisenguss  
pulverbeschichtet  
Klarglas

**Schutzart:**  
IP65



**Lichtrichtung:**



**light technology:**  
230V Power LED  
2700K  
L70/50.000 h

**reflector:** flood

**dimmmable**

**connection:**  
5 m supply cable  
(H05RN8-F 3G0,75 mm<sup>2</sup>)  
incl. safety plug ready  
to connect

[piek lettura controller:  
incl. controller]

movable







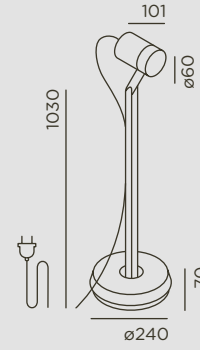

**material:**  
head: aluminium die-casting  
powder-coated  
pole: stainless steel  
powder-coated  
base: iron casting  
powder-coated  
clear glass

**protection class:**  
IP65

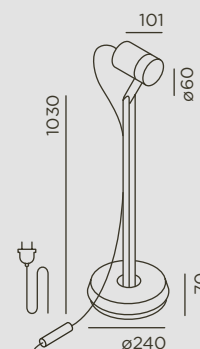

**light direction:**



piek lettura	Farbe colour	Art.-Nr. item no.	Systemleistung system performance
	 anthracite RAL 7016	92075-27-AN	6 W/220 lm
	 cool brown	92075-27-CB	6 W/220 lm
	 deep black RAL 9005	92075-27-BL	6 W/220 lm
	 anthracite RAL 7016	92075-27-AN-CONT	6 W/220 lm
	 cool brown	92075-27-CB-CONT	6 W/220 lm
	 deep black RAL 9005	92075-27-BL-CONT	6 W/220 lm

Größe in mm  
size in mm

+ Optional mit piek cover. Produktdetails Seite 272  
with piek cover as an option. product details page 272

+ Optional mit CH-Stecker . Art.-Nr. + Preise in separater Preisliste + [www.IP44.de](http://www.IP44.de)  
with CH-plug as an option . item no. + prices in separate price list + [www.IP44.de](http://www.IP44.de)

+ Anschluss optional mit IP44.DE connect. Produktdetails Seite 322  
connection with IP44.DE connect as an option. product details page 322

+ piek . Seite page 268  
+ piek mini solar . Seite page 280

Preise in separater Preisliste . prices in separate price list + [www.IP44.de](http://www.IP44.de)

# piek mini solar

piek mini solar ist eine Insellösung im besten Sinne. Mit eigenem Solar- und Speichermodul lässt sich das flexible Up- oder Downlight nämlich überall dort einsetzen, wo Licht gewünscht, aber kein Stromanschluss in der Nähe ist. Autark ist auch ihre Funktion: Die Dämmerungsfunktion aktiviert piek mini solar selbsttätig für die Dauer von 5 Stunden, sobald es dunkelt.

piek mini solar is a stand-alone solution in the best sense of the word. The flexible up- or downlight has its own solar and storage module so it can be used in places where light is needed but where there is no power socket in the vicinity. It is also self-sufficient in terms of functionality: the twilight function activates piek mini solar automatically for 5 hours as soon as it starts to get dark.



Die Leuchte aktiviert sich bei Einbruch der Dunkelheit über die automatische Dämmerungsfunktion. The luminaire switches on when it starts to get dark thanks to the automatic twilight function.

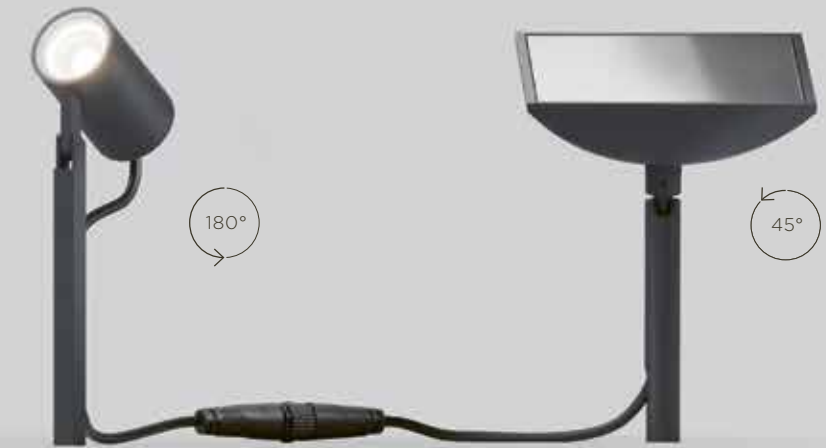

## piek mini solar Design: Sebastian David Büscher

für unbefestigte Beet- und Grünflächen for unpaved beds and greens

**Lichttechnik:**  
LED  
Lithium-Ionen Akku  
1x 2600 mAh  
2700K  
solar panel S

**Reflektor:** Flood

**Anschluss:**  
1 m Zuleitung Leuchte  
(H05RN8-F 2x0,75 mm<sup>2</sup>)  
+ 1 m Zuleitung Solarpanel  
(H05RN8-F 2x0,75 mm<sup>2</sup>)

ortsveränderlich

**Material:**  
Leuchte: Kopf: Aluminiumguss pulverbeschichtet + Stab: Edelstahl pulverbeschichtet + Klarglas  
Solarpanel: Kopf: Aluminiumguss pulverbeschichtet; Stab: Edelstahl pulverbeschichtet; Klarglas

**Schutzart:**  
IP65

**Lichtstrahlung:**

**light technology:**  
LED  
lithium-ion battery  
1x 2600 mAh  
2700K  
solar panel S

**reflector:** flood

**connection:**  
1 m supply cable luminaire  
(H05RN8-F 2x0,75 mm<sup>2</sup>)  
+ 1 m supply cable solar panel  
(H05RN8-F 2x0,75 mm<sup>2</sup>)

movable

**material:**  
luminaire: head: aluminium die-casting powder-coated + pole: stainless steel powder-coated + clear glass  
solar panel: head: aluminium-die-casting powder-coated; pole: stainless steel powder-coated; clear glass

**protection class:**  
IP65

**light direction:**

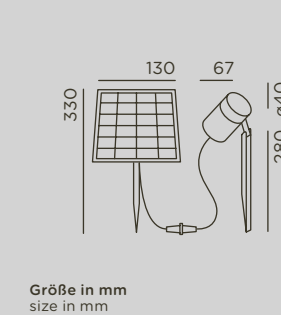

Farbe colour	Art.-Nr. item no.	Systemleistung system performance
anthracite RAL 7016	93076-AN	1,1 W/70 lm
cool brown	93076-CB	1,1 W/70 lm
deep black RAL 9005	93076-BL	1,1 W/70 lm

+ Anschluss optional mit IP44.DE solar join . Produktdetails Seite 348  
connection with IP44.DE solar join as an option . product details page 348

+ piek . Seite page 268  
+ piek lettura . Seite page 276

Preise in separater Preisliste . prices in separate price list + [www.IP44.de](http://www.IP44.de)

# pip poller

Pure Geometrie in einer Pollerleuchte: Der kugelförmige Kopf der pip poller ist axial drehbar gelagert und scheint in der kubischen Grundform zu schweben. Durch stufenloses Drehen des Leuchtenkörpers um 240° setzt dieser formschöne Poller Wege und Beete ins beste Licht.

Pure geometry in a bollard: pip's spherical luminaire head is pivot-mounted in the axial plane and seems to hover in the basic cube shape. By continuously rotating the luminaire body through 240°, this attractive bollard puts paths and beds in the best light.



240°

## pip poller Design: Klaus Nolting



**Lichttechnik:**  
230V Power LED  
2700K  
L70/50.000 h

dimmbar

**Installation:**  
2x Kabeleinführung;  
Anschlussklemme  
3x 1,5 mm<sup>2</sup>;  
Durchgangsverdrahtung mit  
Y-Verbinder in der Leuchte  
möglich

**Montage:**  
Bauseitiges Fundament oder  
befestigter Untergrund

**Material:**  
Aluminiumguss  
pulverbeschichtet  
Sicherheitsglas satiniert

**Schutzart:**  
IP65



**Lichtrichtung:**



light technology:  
230V Power LED  
2700K  
L70/50.000 h

dimmable

installation:  
2x cable entry point;  
connection terminal  
3x 1,5 mm<sup>2</sup>;  
possibility of through wiring  
with Y-connector inside  
luminaire

assembly:  
on site foundation or  
solid ground

material:  
aluminium die-casting  
powder-coated  
safety glass satined

protection class:  
IP65



light direction:

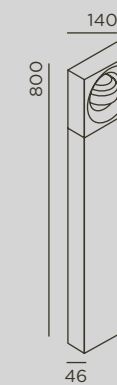

Größe in mm  
size in mm

+ pip . Seite page 172

**Zubehör**  
accessory

**Artikel**  
article

**Art.-Nr.**  
item no.

Y-Verbinder  
Y-connector

55312

Erdstück  
anchorage unit

55099

+ Nähere Informationen Seite 320  
further information page 320

Preise in separater Preisliste . prices in separate price list + [www.IP44.de](http://www.IP44.de)

# reed solar

Unübersehbar inspiriert von der Natur. Auch überall dort zuhause, wo Schilf und Seen nicht in unmittelbarer Nähe sind. Die reed solar mit edlem rauchfarbenem Glaskörper und schlichtem Aluminiumstab setzt in zwei verschiedenen Höhen die Gartenplätze in Szene, die von der Sonne verwöhnt werden, aber ohne Stromanschluss sind.

Unmistakably inspired by nature. Also at home even in places where there are no reeds or lakes nearby. reed solar with its refined smoke-coloured glass body, simple aluminium pole and two different heights, creates the right setting for those parts of the garden that are blessed with sunshine but have no power connection.

**NEW**

Kein Strom in der Nähe? Mit eigenem Solar- und Speichermodul bringt die reed solar trotzdem Licht ins Dunkel! Die Leuchte aktiviert sich bei Einbruch der Dunkelheit über die automatische Dämmerungsfunktion. No electricity nearby? reed solar comes with its own solar and storage module so it still brings light into the darkness! The luminaire switches on when it starts to get dark thanks to the automatic twilight function.



## reed solar Design: Sebastian David Büscher

für unbefestigte Beet- und Grünflächen for unpaved beds and greens

<b>Lichttechnik:</b> LED Lithium-Ionen Akku 1x 2600 mAh 2700K solar panel S  <b>Anschluss:</b> 1,4 m (reed M)/1,2 m (reed L) Zuleitung Leuchte (H05RN8-F 2x0,75 mm <sup>2</sup> ) + 1 m Zuleitung Solarpanel (H05RN8-F 2x0,75 mm <sup>2</sup> )  ortsveränderlich	<b>Material:</b> Leuchte: Aluminiumguss pulverbeschichtet + rauchfarbenes Glas Solarpanel: Kopf: Aluminiumguss pulverbeschichtet; Stab: Edelstahl pulverbeschichtet; Klarglas  <b>Schutzart:</b> IP65  A E  <b>Lichtrichtung:</b> 	<b>light technology:</b> LED lithium-ion battery 1x 2600 mAh 2700K solar panel S  <b>connection:</b> 1,4 m (reed M)/1,2 m (reed L) supply cable luminaire (H05RN8-F 2x0,75 mm <sup>2</sup> ) + 1 m supply cable solar panel (H05RN8-F 2x0,75 mm <sup>2</sup> )  movable	<b>material:</b> luminaire: aluminium die-casting powder-coated + smoke-coloured glass solar panel: head: aluminium-die-casting powder-coated; pole: stainless steel powder-coated; clear glass  <b>protection class:</b> IP65  A E  <b>light direction:</b> 
---	--	---	---

reed M solar	Farbe colour	Art.-Nr. item no.	Systemleistung system performance
	deep black RAL 9005	93821-BL	1,1 W/22 lm

	deep black RAL 9005	93822-BL	1,1 W/22 lm
--	------------------------	----------	-------------

Größe in mm  
size in mm

+ Anschluss optional mit IP44.DE solar join . Produktdetails Seite 348  
connection with IP44.DE solar join as an option . product details page 348

Preise in separater Preisliste . prices in separate price list + [www.IP44.de](http://www.IP44.de)

shot



ground



# shot

Lichtquelle und Lichtobjekt in einem: Die massive, ortsveränderliche Lichtkugel mit fortschrittlichem Innenleben lässt sich auf dem shot ring auf festen Untergründen frei in jede Himmelsrichtung positionieren. Alternativ fixiert oder hebt der shot tee die Kugel auf eine andere Ebene, oder trägt der shot hook die Kugel an der Wand.

Light source and light object in one: the solid movable ball of light with highly advanced interior can be freely positioned on the shot ring in any direction of the compass. Alternatively the shot tee fixes or lifts the ball to another level, or shot hook brings the ball to the wall.



shot + shot ring zum Einsatz auf festen Untergründen, wie z.B. Terrassen, Podesten oder Balkonen. Mit Alu-Ring lose und 5 m Zuleitung anschlussfertig. shot + shot ring for use on solid surfaces such as terraces, platforms or balconies. With loose aluminium ring and 5 m supply cable ready to connect.



reddot award 2017  
winner

shot



ground

# shot

Der shot tee ist als erforderliches Zubehörteil für den Einsatz der massiven Aluminiumguss-Kugel shot in unbefestigten Beeten und Rasenflächen zu verwenden. Der Bodenstrahler ist mit einem Flood Reflektor ausgestattet, Kabel und Stecker sind im Lieferumfang enthalten.

shot tee as required accessory is to be used to anchor the solid aluminium die-casting ball in unpaved beds or lawns. The floor spotlight is equipped with flood reflector; cable and plug are included in the scope of delivery.



reddot award 2017  
winner

shot + shot tee: Die Kugel shot  
wird in den shot tee gelegt.  
shot + shot tee: the ball shot is  
placed in the shot tee.

# shot

shot, der Charakterdarsteller: Mit shot hook lässt sich der Bodenstrahler shot an Fassaden befestigen und in ein flexibles Uplight verwandeln, um Wandflächen zu illuminieren.

shot, the luminaire with a real character: shot hook can be fixed to facades and convert the floor spotlight shot into a flexible uplight for illuminating wall surfaces.



Wahlweise per Wandanschluss, mit bauseits zu kürzendem Kabel, das durch die Wandhalterung geführt wird. Oder aber mit sichtbarem Kabel und direktem Anschluss in Schutzkontaktsteckdose. Optionally by wall connection, with cable to be shortened on site and to be conducted through wall bracket. As an alternative with visible cable and direct connection to safety plug.





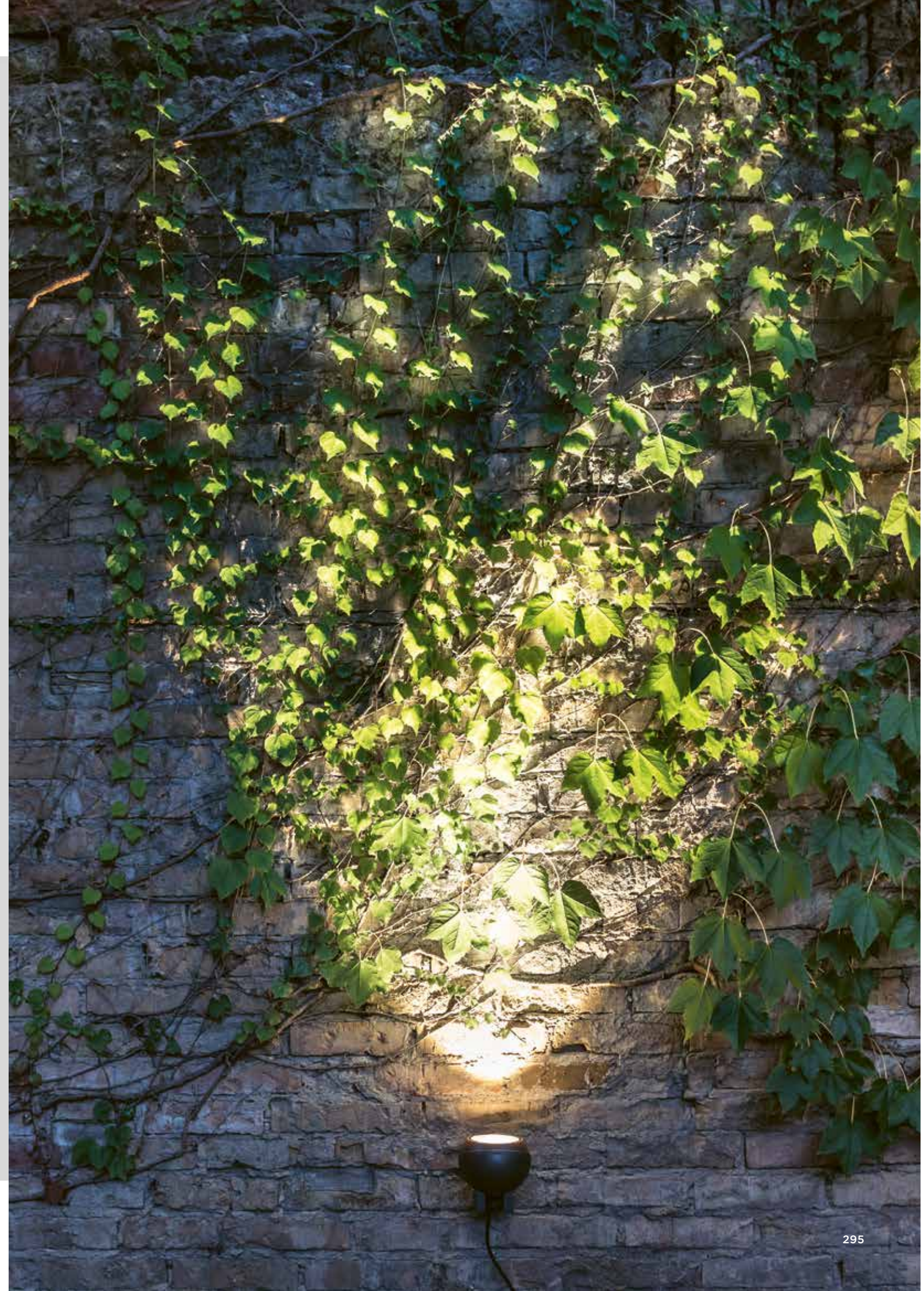

reddot award 2017  
winner





## shot Design: Sebastian David Büscher

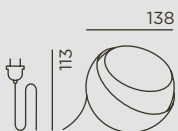
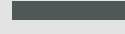
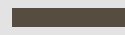

<p><b>Lichttechnik:</b> 230V Power LED 2700K L70/50.000 h</p> <p><b>Reflektor: Flood</b> dimmbar</p> <p><b>Anschluss:</b> 5 m Zuleitung (H05RN8-F 3G0,75 mm<sup>2</sup>) inkl. Schutzkontaktstecker anschlussfertig</p> <p>ortsveränderlich</p>	<p><b>Material:</b> Aluminiumguss pulverbeschichtet Sicherheitsglas klar</p> <p><b>Schutzart:</b> IP65</p> <p></p> <p><b>Lichtrichtung:</b> </p>	<p><b>light technology:</b> 230V Power LED 2700K L70/50.000 h</p> <p><b>reflector: flood</b> dimmbare</p> <p><b>connection:</b> 5 m supply cable (H05RN8-F 3G0,75 mm<sup>2</sup>) incl. safety plug ready to connect</p> <p>movable</p>	<p><b>material:</b> aluminium die-casting powder-coated safety glass clear</p> <p><b>protection class:</b> IP65</p> <p></p> <p><b>light direction:</b> </p>
---	--	---	---

shot 4 W	Farbe colour	Art.-Nr. item no.	Systemleistung system performance
	 anthracite RAL 7016	91090-27-4W-AN	4 W/219 lm
	 cool brown	91090-27-4W-CB	4 W/219 lm
	 deep black RAL 9005	91090-27-4W-BL	4 W/219 lm

shot 15 W	Farbe colour	Art.-Nr. item no.	Systemleistung system performance
	 anthracite RAL 7016	91090-27-15W-AN	15 W/874 lm
	 cool brown	91090-27-15W-CB	15 W/874 lm
	 deep black RAL 9005	91090-27-15W-BL	15 W/874 lm

+ Optional mit CH-Stecker . Art.-Nr. + Preise in separater Preisliste + [www.IP44.de](http://www.IP44.de)  
with CH-plug as an option . item no. + prices in separate price list + [www.IP44.de](http://www.IP44.de)

+ Anschluss optional mit IP44.DE connect. Produktdetails Seite 322  
connection with IP44.DE connect as an option. product details page 322



für festen Untergrund  
for solid ground

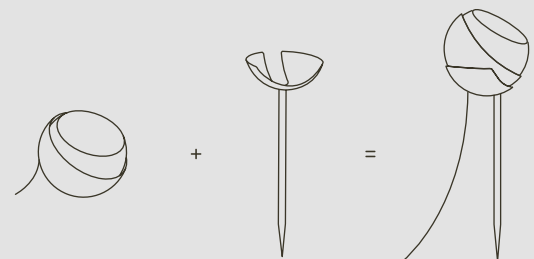

für unbefestigte Beet-  
und Grünflächen  
for unpaved beds  
and greens

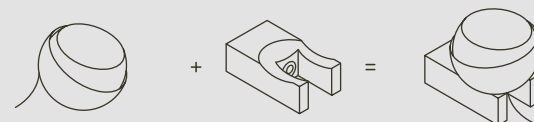

für Wandmontage  
for wall mounting

Preise in separater Preisliste . prices in separate price list + [www.IP44.de](http://www.IP44.de)

## Erforderliches Zubehör required accessory

### shot ring

für festen Untergrund for solid ground



Farbe colour	Art.-Nr. item no.	Material material
 anthracite RAL 7016	91090-R-AN	Aluminiumguss pulverbeschichtet aluminium die-casting powder-coated
 cool brown	91090-R-CB	Aluminiumguss pulverbeschichtet aluminium die-casting powder-coated
 deep black RAL 9005	91090-R-BL	Aluminiumguss pulverbeschichtet aluminium die-casting powder-coated

### shot tee

für unbefestigte Beet- und Grünflächen for unpaved beds and greens

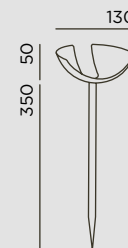

Farbe colour	Art.-Nr. item no.	Material material
 anthracite RAL 7016	91091-AN	Schale: Aluminiumguss pulverbeschichtet Stab: Edelstahl pulverbeschichtet bowl: aluminium die-casting powder-coated pole: stainless steel powder-coated
 cool brown	91091-CB	Schale: Aluminiumguss pulverbeschichtet Stab: Edelstahl pulverbeschichtet bowl: aluminium die-casting powder-coated pole: stainless steel powder-coated
 deep black RAL 9005	91091-BL	Schale: Aluminiumguss pulverbeschichtet Stab: Edelstahl pulverbeschichtet bowl: aluminium die-casting powder-coated pole: stainless steel powder-coated

### shot hook

für Wandmontage for wall mounting

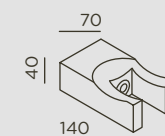

Farbe colour	Art.-Nr. item no.	Material material
 anthracite RAL 7016	91092-AN	Aluminiumguss pulverbeschichtet aluminium die-casting powder-coated
 cool brown	91092-CB	Aluminiumguss pulverbeschichtet aluminium die-casting powder-coated
 deep black RAL 9005	91092-BL	Aluminiumguss pulverbeschichtet aluminium die-casting powder-coated

Größe in mm  
size in mm

Preise in separater Preisliste . prices in separate price list + [www.IP44.de](http://www.IP44.de)

slat poller



ground

# slat poller

Die Pollerleuchte slat stellt mit ihrer um 240° verstellbaren Lamelle eine hervorragende Wegebeleuchtung dar. Die Leuchte ist in den Höhen 40 cm und 70 cm erhältlich. Mit seinem gerichteten Licht stellt sich der slat poller in bester Weise auf jede lichttechnische Situation ein!

The bollard luminaire slat with its 240°-rotating light blade provides excellent path lighting. It is available at heights of 40 cm and 70 cm. slat poller with its directed light adapts perfectly to any specific lighting situation.



240°

slat poller in den Höhen  
40 cm + 70 cm  
slat poller in the heights  
40 cm + 70 cm

## slat poller Design: Klaus Nolting



**Lichttechnik:**  
230V Power LED  
2700K  
L70/50.000 h

dimmbar

**Installation:**  
2x Kabeleinführung;  
Anschlussklemme  
3x 1,5 mm<sup>2</sup>;  
Durchgangsverdrahtung mit  
Y-Verbinder in der Leuchte  
möglich

**Montage:**  
Bauseitiges Fundament oder  
befestigter Untergrund

**Material:**  
Aluminiumguss  
pulverbeschichtet  
Sicherheitsglas satiniert

**Schutzart:**  
IP65



**Lichtrichtung:**



**light technology:**  
230V Power LED  
2700K  
L70/50.000 h

dimmbare

**installation:**  
2x cable entry point;  
connection terminal  
3x 1,5 mm<sup>2</sup>;  
possibility of through wiring  
with Y-connector inside  
luminaire

**assembly:**  
on site foundation or  
solid ground

**material:**  
aluminium die-casting  
powder-coated  
safety glass satined

**protection class:**  
IP65



**light direction:**



### slat 40 poller

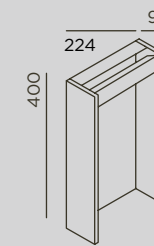

**Farbe**  
colour

anthracite  
RAL 7016

cool brown

space grey

deep black  
RAL 9005

**Art.-Nr.**  
item no.

91031-27-AN

91031-27-CB

91031-27-SG

91031-27-BL

**Systemleistung**  
system performance

8 W/280 lm

8 W/280 lm

8 W/280 lm

8 W/280 lm

### slat 70 poller

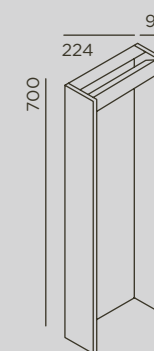

anthracite  
RAL 7016

cool brown

space grey

deep black  
RAL 9005

91032-27-AN

91032-27-CB

91032-27-SG

91032-27-BL

8 W/280 lm

8 W/280 lm

8 W/280 lm

8 W/280 lm

Größe in mm  
size in mm

+ slat wall . Seite page 184  
+ slat one wall . Seite page 188  
+ slat ceiling . Seite page 210  
+ slat spike . Seite page 302

**Zubehör**  
accessory

**Artikel**  
article

**Art.-Nr.**  
item no.

Y-Verbinder  
Y-connector

55312

Erdstück  
anchorage unit

55099

+ Nähere Informationen Seite 320  
further information page 320

Preise in separater Preisliste . prices in separate price list + [www.IP44.de](http://www.IP44.de)

slat spike





# slat spike

Der slat spike ergänzt die Produktfamilie slat um einen ortsveränderlichen Bodenspieß. Der um 240° verstellbare Lichtbalken erzeugt gleichmäßiges, diffuses Licht und schafft einzigartige Lichtinseln oder auch außergewöhnliche Wegebeleuchtung.

slat spike adds a movable ground spike to the product family. The light blade rotates through 240°, generating a uniform, diffuse light effect and creating unique pools of light or unusual path lighting.



## slat spike Design: Klaus Nolting

für unbefestigte Beet- und Grünflächen for unpaved beds and greens

**Lichttechnik:**  
230V Power LED  
2700K  
L70/50.000 h

dimmbar

**Anschluss:**  
5 m Zuleitung  
(H05RN8-F 3G0,75 mm<sup>2</sup>)  
inkl. Schutzkontaktstecker  
anschlussfertig

ortsveränderlich

**Material:**  
Kopf: Aluminiumguss  
pulverbeschichtet  
Spieß: Edelstahl  
pulverbeschichtet  
Sicherheitsglas satiniert

**Schutzart:**  
IP65



**Lichtrichtung:**



light technology:  
230V Power LED  
2700K  
L70/50.000 h

dimmable

**connection:**  
5 m supply cable  
(H05RN8-F 3G0,75 mm<sup>2</sup>)  
incl. safety plug  
ready to connect

movable

material:  
head: aluminium die-casting  
powder-coated  
spike: stainless steel  
powder-coated  
safety glass satined

protection class:  
IP65



light direction:

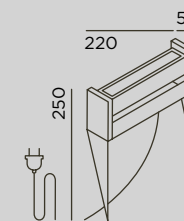

Größe in mm  
size in mm

**Farbe**  
colour

 anthracite  
RAL 7016

 cool brown

 deep black  
RAL 9005

**Art.-Nr.**  
item no.

91030-27-AN

91030-27-CB

91030-27-BL

**Systemleistung**  
system performance

8 W/280 lm

8 W/280 lm

8 W/280 lm

- + slat wall . Seite page 184
- + slat one wall . Seite page 188
- + slat ceiling . Seite page 210
- + slat poller . Seite page 298

+ Optional mit CH-Stecker . Art.-Nr. + Preise in separater Preisliste + [www.IP44.de](http://www.IP44.de)  
with CH-plug as an option . item no. + prices in separate price list + [www.IP44.de](http://www.IP44.de)

+ Anschluss optional mit IP44.DE connect. Produktdetails Seite 322  
connection with IP44.DE connect as an option. product details page 322

Preise in separater Preisliste . prices in separate price list + [www.IP44.de](http://www.IP44.de)

stic



ground

# stic

Wer Natur oder Architektur ins beste Licht setzen will, kommt um stic nicht herum. Bislang rein als Bodenstrahler im Einsatz, erhält sie jetzt Konsole und schwenkbares Gelenk für die Montage an Wand, Decke oder Boden - überall dort, wo ebenso brillantes wie fokussiertes Licht gebraucht wird.

If you want to put nature or architecture in the best light, you can't avoid stic. Designed originally as a pure ground spotlight, it has now been fitted with a bracket and swivel joint for mounting to the wall, ceiling or floor - wherever there is a need for both brilliant and focused light.



Der Leuchtenkopf ist dreh- und schwenkbar.  
The luminaire head can be turned and swiveled.



## stic Design: Klaus Nolting



**Lichttechnik:**  
230V Power LED  
2700K  
L70/50.000 h

**Reflektor:** Flood

dimmbar

**Installation:**  
2x Kabeleinführung;  
Anschlussklemme  
3x 1,5 mm<sup>2</sup>

**Montage:**  
Bauseitiges Fundament oder  
befestigter Untergrund

**Material:**  
Kopf: Aluminiumguss  
pulverbeschichtet  
Konsole: Edelstahl  
pulverbeschichtet  
Sicherheitsglas klar

**Schutzart:**  
IP65



**Lichtrichtung:**



**light technology:**  
230V Power LED  
2700K  
L70/50.000 h

**reflector:** flood

dimmable

**installation:**  
2x cable entry point;  
connection terminal  
3x 1,5 mm<sup>2</sup>

**assembly:**  
on site foundation or  
solid ground

**material:**  
head: aluminium die-casting  
powder-coated  
bracket: stainless steel  
powder-coated  
safety glass clear

**protection class:**  
IP65



**light direction:**

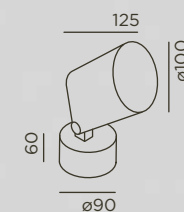

Größe in mm  
size in mm

**Farbe**  
colour

anthracite  
RAL 7016

cool brown

deep black  
RAL 9005

**Art.-Nr.**  
item no.

91760-AN

91760-CB

91760-BL

**Systemleistung**  
system performance

8 W/559 lm

8 W/559 lm

8 W/559 lm

- + stic wall . Seite page 192
- + stic control . Seite page 196
- + stic ceiling . Seite page 214
- + stic spike . Seite page 310

Preise in separater Preisliste . prices in separate price list + [www.IP44.de](http://www.IP44.de)

stic spike



# stic spike

Unser ortsveränderlicher Bodenstrahler stic spike bietet Orientierung und Helligkeit. Er setzt gleichermaßen Bäume und Sträucher in Szene, dient aber auch als Objekt- oder Wegebeleuchtung. Der spezielle Schwenkpunkt kippt den gesamten Leuchtenkopf über den Erdspeiß, so ist der stic spike stufenlos als Up- oder Downlight einstellbar, oder richtet das Licht dorthin, wo es benötigt wird.

Our movable ground spotlight stic spike offers guidance and brightness. It creates a setting for trees and shrubs, while also serving as object or path lighting. The special swivel point tilts the whole luminaire head over the ground spike for fully variable adjustment of stic spike as an up- or downlight, or it points the light to where it is needed.





stic spike in den Höhen  
30 cm + 70 cm  
stic spike in the heights  
30 cm + 70 cm







# stic spike

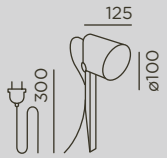

## stic spike Design: Klaus Nolting

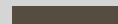
für unbefestigte Beet- und Grünflächen for unpaved beds and greens

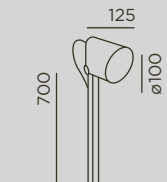
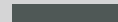
<b>Lichttechnik:</b> 230V Power LED 2700K L70/50.000 h	<b>Material:</b> Kopf: Aluminiumguss pulverbeschichtet Stab: Edelstahl pulverbeschichtet Sicherheitsglas klar	<b>light technology:</b> 230V Power LED 2700K L70/50.000 h	<b>material:</b> head: aluminium die-casting powder-coated pole: stainless steel powder-coated glass: safety glass clear
<b>Reflektor: Flood</b>  dimmbar	<b>Schutzart:</b> IP65	<b>reflector: flood</b>  dimmable	<b>protection class:</b> IP65
<b>Anschluss:</b> 5 m Zuleitung (H05RN8-F 3G0,75 mm <sup>2</sup> ) inkl. Schutzkontaktstecker anschlussfertig		<b>connection:</b> 5 m supply cable (H05RN8-F 3G0,75 mm <sup>2</sup> ) incl. safety plug ready to connect	
<b>ortsveränderlich</b>	<b>Lichtrichtung:</b> 	movable	<b>light direction:</b> 

stic 30 spike	Farbe colour	Art.-Nr. item no.	Systemleistung system performance
	 anthracite RAL 7016	91061-27-AN	8 W/559 lm
	 cool brown	91061-27-CB	8 W/559 lm
	 deep black RAL 9005	91061-27-BL	8 W/559 lm
	 anthracite RAL 7016	91060-27-AN	8 W/559 lm
	 cool brown	91060-27-CB	8 W/559 lm
	 deep black RAL 9005	91060-27-BL	8 W/559 lm

Größe in mm  
size in mm

+ Optional mit CH-Stecker . Art.-Nr. + Preise in separater Preisliste + [www.IP44.de](http://www.IP44.de)  
with CH-plug as an option . item no. + prices in separate price list + [www.IP44.de](http://www.IP44.de)

+ Anschluss optional mit IP44.DE connect. Produktdetails Seite 322  
connection with IP44.DE connect as an option. product details page 322

- + stic wall . Seite page 192
- + stic control . Seite pag 196
- + stic ceiling . Seite page 214
- + stic ground . Seite page 306

Preise in separater Preisliste . prices in separate price list + [www.IP44.de](http://www.IP44.de)

jack



# jack

Die auf den absoluten Kern reduzierte und ästhetisch gestaltete Steckdosensäule vervollständigt das IP44.DE Portfolio. Durch den Einsatz von hochwertigem Aluminiumguss zeugt jack von höchster Verarbeitungsqualität. Die Anschluss säule mit zwei Schutzkontaktsteckdosen ist sowohl für den Anschluss ortsveränderlicher Leuchten, als auch zur Versorgung elektrischer Geräte einsetzbar.

The aesthetically designed connecting pillar has been reduced to its absolute core and rounds off the IP44.DE portfolio. jack is made of top quality aluminium die-casting in absolutely convincing first-rate workmanship. The connecting pillar with two safety sockets can be used to connect movable luminaires and also for electrical appliances.



Einsatz auf bauseitigem Fundament oder befestigtem Untergrund, oder optional auch mit dem IP44.DE Erdstück. Kabelführung erfolgt durch den vertikalen Spalt der Abdeckklappe. Can be put on the on site foundations or on a solid ground, or used with the IP44.DE anchorage unit as an option. The cable is taken through the vertical gap in the cap.



Die Abdeckklappe verdeckt die beiden Steckdosen. The two sockets are concealed by the cap.



## jack Design: IP44.DE

inkl. 2x Schutzkontaktsteckdosen (belgische-/französische + Schweizer Norm möglich)

Installation:  
Anschlussklemme 5x 1,5 mm<sup>2</sup>;  
Durchgangsverdrahtung mit Y-Verbinder in der Säule möglich

Montage:  
Bauseitiges Fundament oder befestigter Untergrund

Material:  
Aluminiumguss pulverbeschichtet

Schutzart:  
IP54

incl. 2x safety sockets (Belgian/French + Swiss norm possible)

installation:  
connection terminal 5x 1,5 mm<sup>2</sup>;  
possibility of through wiring with Y-connector inside pillar

assembly:  
on site foundation or solid ground

material:  
aluminium die-casting powder-coated

protection class:  
IP54



Größe in mm  
size in mm

Farbe colour	Art.-Nr. item no.	Art.-Nr. item no.	Art.-Nr. item no.
anthracite RAL 7016	55090-AN	55090-BEFR-AN	55090-CH-AN
cool brown	55090-CB	55090-BEFR-CB	55090-CH-CB
deep black RAL 9005	55090-BL	55090-BEFR-BL	55090-CH-BL

Zubehör  
accessory

Art.-Nr.  
item no.

Y-Verbinder  
Y-connector

55312

Erdstück  
anchorage unit

55099

+ Nähere Informationen Seite 320  
further information page 320

Preise in separater Preisliste . prices in separate price list + [www.IP44.de](http://www.IP44.de)



# ground Zubehör accessory

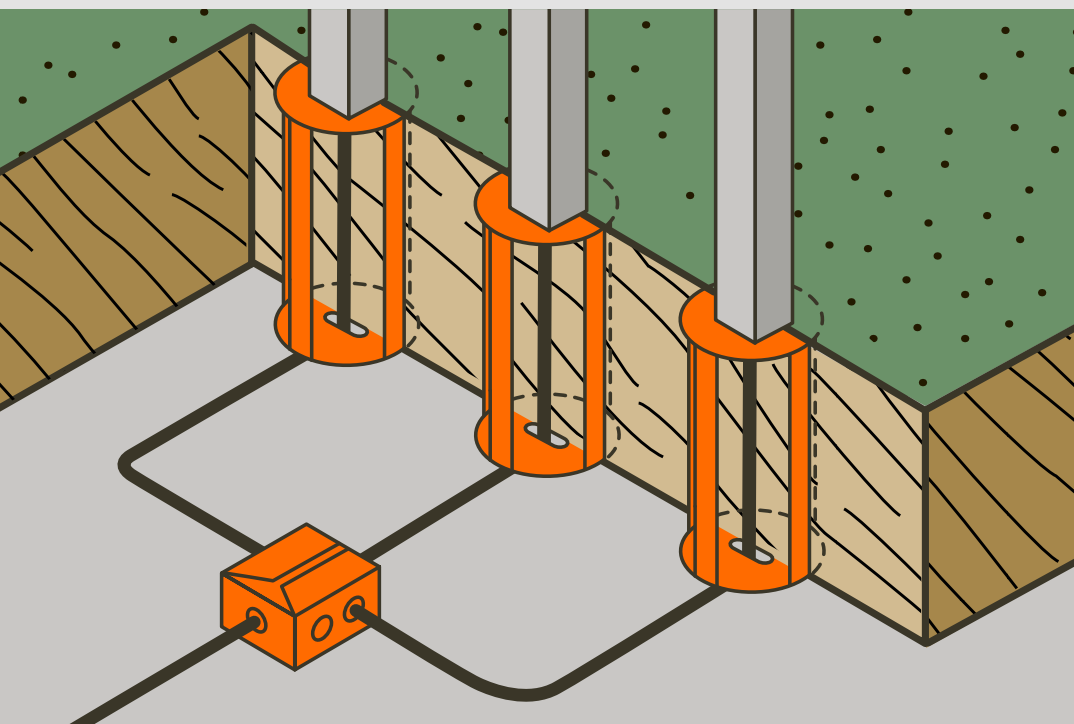

## Sternverdrahtung: Erd-Abzweigkasten star wiring: earth distribution box

Der wasserdichte Erd-Abzweigkasten ermöglicht den Anschluss im Erdreich von bis zu 6 Poller-/Einbauleuchten an die bauseitig verlegte Zuleitung. Alle elektrischen Leitungen werden nach der Installation in dem Erd-Abzweigkasten mit dem mitgelieferten Gießharz verschlossen.

Das PU-beschichtete Erdstück aus Edelstahl ist für alle IP44.DE Pollerleuchten und unsere Steckdosensäule geeignet. Das bauseitig verlegte Erdkabel wird mittig eingeführt und zusammen mit dem Erdstück einbetoniert.

The waterproof earth distribution box can be used to connect up to 6 bollards/in-ground luminaires in the ground to the supply line installed by the customer. After installation, all electric cables are sealed in the earth distribution box with the supplied cast resin.

The PU-coated anchorage unit is made of stainless steel and suitable for all IP44.DE bollard luminaires and for our connecting pillar. The underground cable installed by the customer is inserted centrally and concreted in together with the anchorage unit.

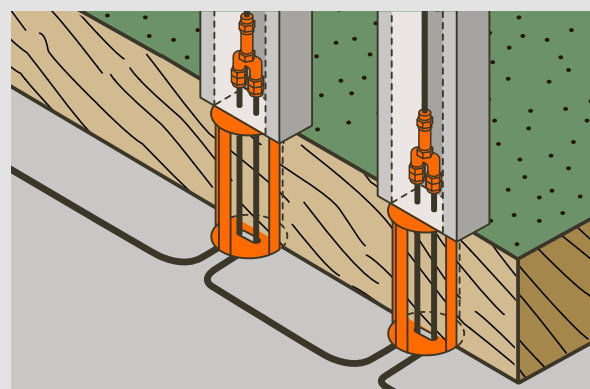

## Durchgangsverdrahtung: Y-Verbinder through wiring: Y-connector

Der Y-Verbinder ermöglicht eine einfache Durchgangsverdrahtung direkt in der Pollerleuchte durch die bauseitigen Zuleitungen.

The Y-connector permits simple through wiring directly into the bollard luminaire through the customer's supply lines.

Zubehör  
accessory

Artikel  
article

Art.-Nr.  
item no.

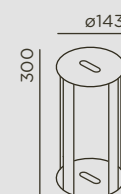

**Erdstück**  
anchorage unit

55099

**Material: Edelstahl PU-Beschichtung schwarz**  
material: stainless steel PU-coating black

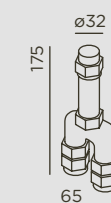

**Y-Verbinder**  
Y-connector

55312

**Schutzart: IP68**  
**Installation: Anschlussklemme 5x 1,5 mm<sup>2</sup>**  
protection class: IP68  
installation: connection terminal 5x 1,5 mm<sup>2</sup>

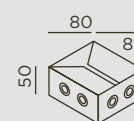

**Erd-Abzweigkasten**  
**inkl. Anschlussklemme + Gießharz**  
earth distribution box incl. connection terminal + cast resin

55380

**Schutzart: IP68**  
**Installation: 7x Kabeleinführung; Anschlussklemme 5x 2,5 mm<sup>2</sup>**  
protection class: IP68  
installation: 7x cable entry point; connection terminal 5x 2,5 mm<sup>2</sup>

Größe in mm  
size in mm

Preise in separater Preisliste . prices in separate price list + [www.IP44.de](http://www.IP44.de)

connect



Kein anderes System kombiniert derart viele Vorteile wie IP44.DE connect!  
No other system combines as many advantages as IP44.DE connect.

## Bestens verbunden Best connections

Sein Name sagt es bereits: Mit IP44.DE connect lassen sich all unsere ortsveränderlichen LED-Außenleuchten anschließen, und zwar einfacher und schneller als je zuvor. Eine aufwändige Verlegung von Erdkabeln, Vorinstallationen und teure Montagen entfallen. Verändern sich Bepflanzung, Architektur oder Geschmack, lässt sich das System jederzeit erweitern und verändern. Und damit es draußen sofort losgehen kann, liefern wir unsere Leuchtenmodelle lin, pad, piek, piek lettura, shot, slat spike, stic spike sowie in A + in S gleich mit IP44.DE connect Stecker aus. Intelligentes Detail: In Kombination mit dem IP44.DE Controller ist das System sogar smartfähig!

As the name says, IP44.DE connect can be used to connect all our movable LED outside luminaires, now simpler and faster than ever before. This dispenses entirely with any complicated routing of underground cables, preliminary assembly and expensive installation. It is a system that can be extended and modified at any time to allow for changes in planting, architecture or taste. Our luminaire models lin, pad, piek, piek lettura, shot, slat spike, stic spike, as well as in A + in S come supplied with IP44.DE connect plugs to make them ready for immediate outside use. Smart detail: when combined with the IP44.DE controller, the system can even be used in smart solutions!

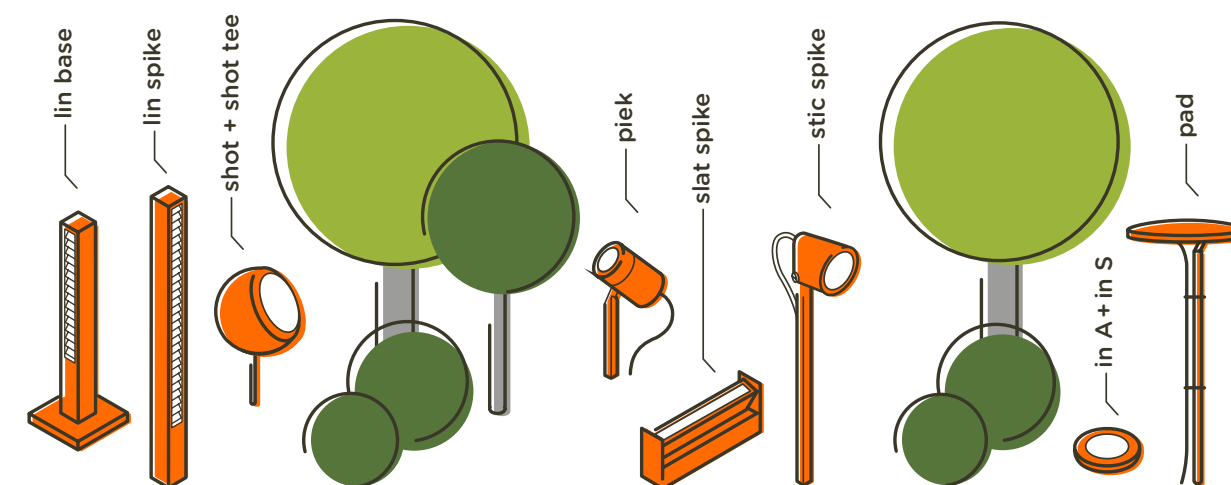
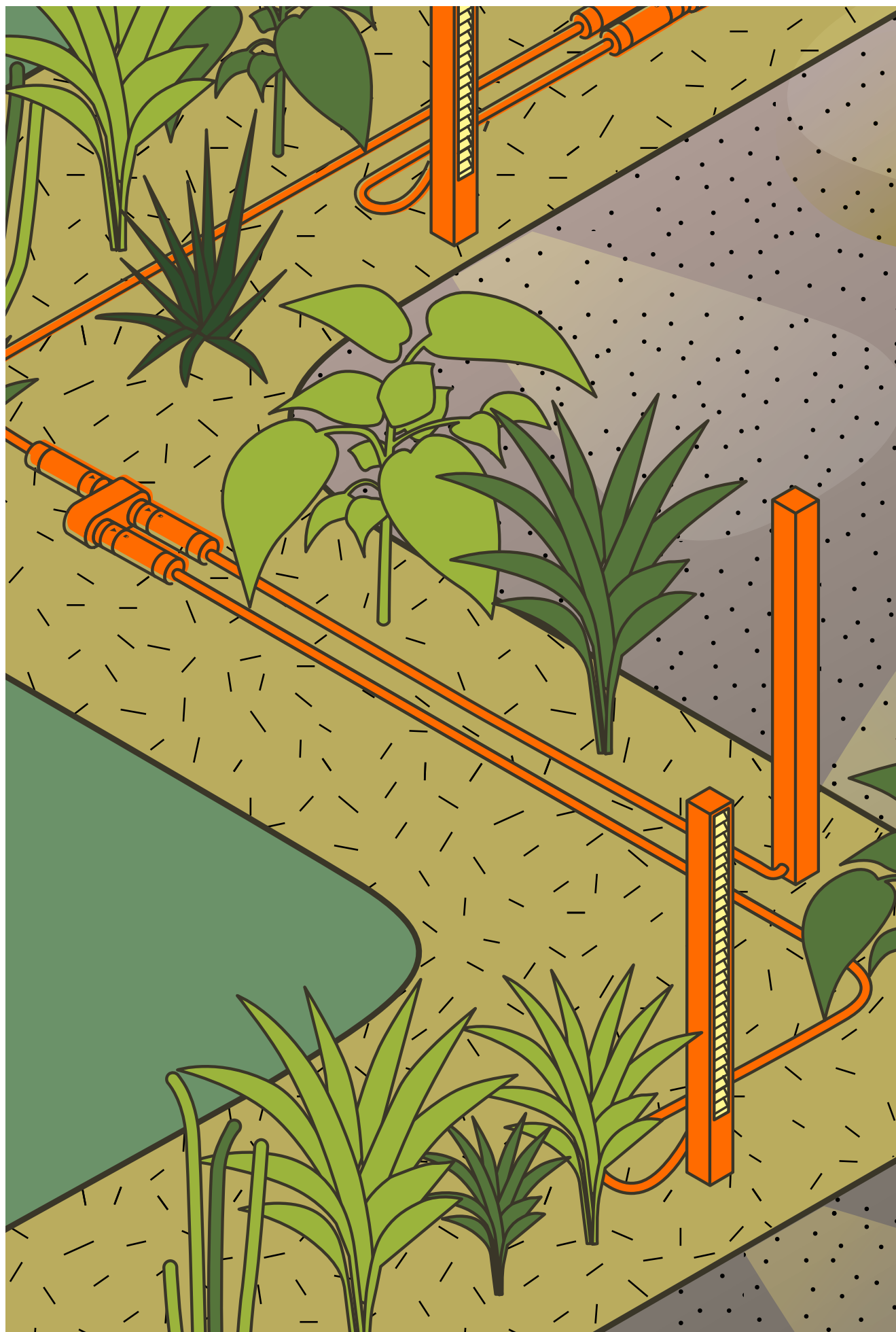

## Anpassungsfähig Adaptable

Von zwei Leuchten für den kleinen Balkon bis zu komplexen Lichtszenarien für große Gärten - IP44.DE connect versorgt sie alle zuverlässig mit Energie.

Unsere Leuchtenmodelle lin, pad, piek, piek lettura, shot, slat spike, stic spike sowie in A + in S werden gleich mit dem passenden Anschluss geliefert. Und wenn die Ansprüche wachsen oder sich die Gartenarchitektur verändert, wächst IP44.DE connect einfach mit. Das System lässt sich jederzeit im Handumdrehen umbauen, erweitern oder auch verkleinern.

From two luminaires on a small balcony to complex light scenarios in large gardens - IP44.DE connect keeps them all supplied reliably with energy.

Our luminaire models lin, pad, piek, piek lettura, shot, slat spike, stic spike, as well as in A + in S come ready supplied with the right connection. And when demands grow or the garden architecture is changed, IP44.DE connect simply grows as well. The system can be modified, extended or even reduced in next to no time.

# 6 gute Gründe für IP44.DE connect

## 6 good reasons for IP44.DE connect

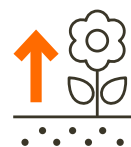

### Simple Verlegung simple routing

IP44.DE connect wird ganz einfach oberirdisch ausgelegt und beispielsweise zwischen immergrünen Bodendeckern verlegt.

IP44.DE connect is simply laid out above ground and routed for example between evergreen ground-cover plants.



### DIY-Montage DIY assembly

Keine hohen Stundenabrechnungen von Fachhandwerkern – dank Do-It-Yourself-Montage.

No need to pay the expensive hourly rates of specialists, thanks to do-it-yourself assembly.



### Einfache Installation easy installation

Gut, wenn man Werkzeug hat – aber für IP44.DE connect braucht man lediglich zwei Hände.

Tools are a good thing, but you only need two hands for IP44.DE connect.

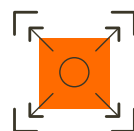

### Flexible Erweiterbarkeit flexible extensibility

Ein IP44.DE connect-System reicht so weit, wie Phantasie (und Garten) reichen.

An IP44.DE connect system extends as far as your imagination (and garden) goes.



### Volle Energie full of energy

Als 230 Volt-System benötigt IP44.DE connect weder Trafo noch aufwändige Vorschalttechnik.

IP44.DE connect is a 230 volt system that needs neither transformers nor complicated ballast technology.



### Intelligente Steuerung smart control

Per App und Controller lässt sich das System konfigurieren und über Smartphone oder Tablet steuern.

The system can be configured by app and controller and controlled from a smartphone or tablet.





Dank Hochvoltspannung lassen sich auch längere Leitungen verlegen – ganz ohne Trafos und Spannungsverluste.

The high voltage rating also allows for longer leads, without transformers and voltage loss.

## Große Freiheit Great freedom

So unterschiedlich wie Gärten und Balkone, so vielfältig sind auch die Beleuchtungsaufgaben, die es im Außenbereich zu lösen gilt. Das Schöne: IP44.DE connect ist für all diese Aufgaben wie geschaffen. Ganz ohne Erdarbeiten lassen sich unterschiedlichste Lichtpunkte setzen. Und weil unser System oberirdisch verlegt wird, lassen sich Lichtszenarien jederzeit verändern, ohne dass Fachhandwerker oder Baugerät anrücken müssten. IP44.DE connect steht also für die große Freiheit in der Außenbeleuchtung – bei erfreulich überschaubarem Aufwand.

Gardens and balconies can differ greatly. The same can also be said of the many diverse lighting tasks to be solved in the outside setting. Fortunately, IP44.DE connect is tailor-made for all these tasks. Many different light accents can be set without any need for earthworks. And the fact that the system is laid above ground means that light settings can be changed at any time without having to call in specialists or use construction machinery. And so IP44.DE connect offers great freedom for outside lighting, at pleasingly low cost.

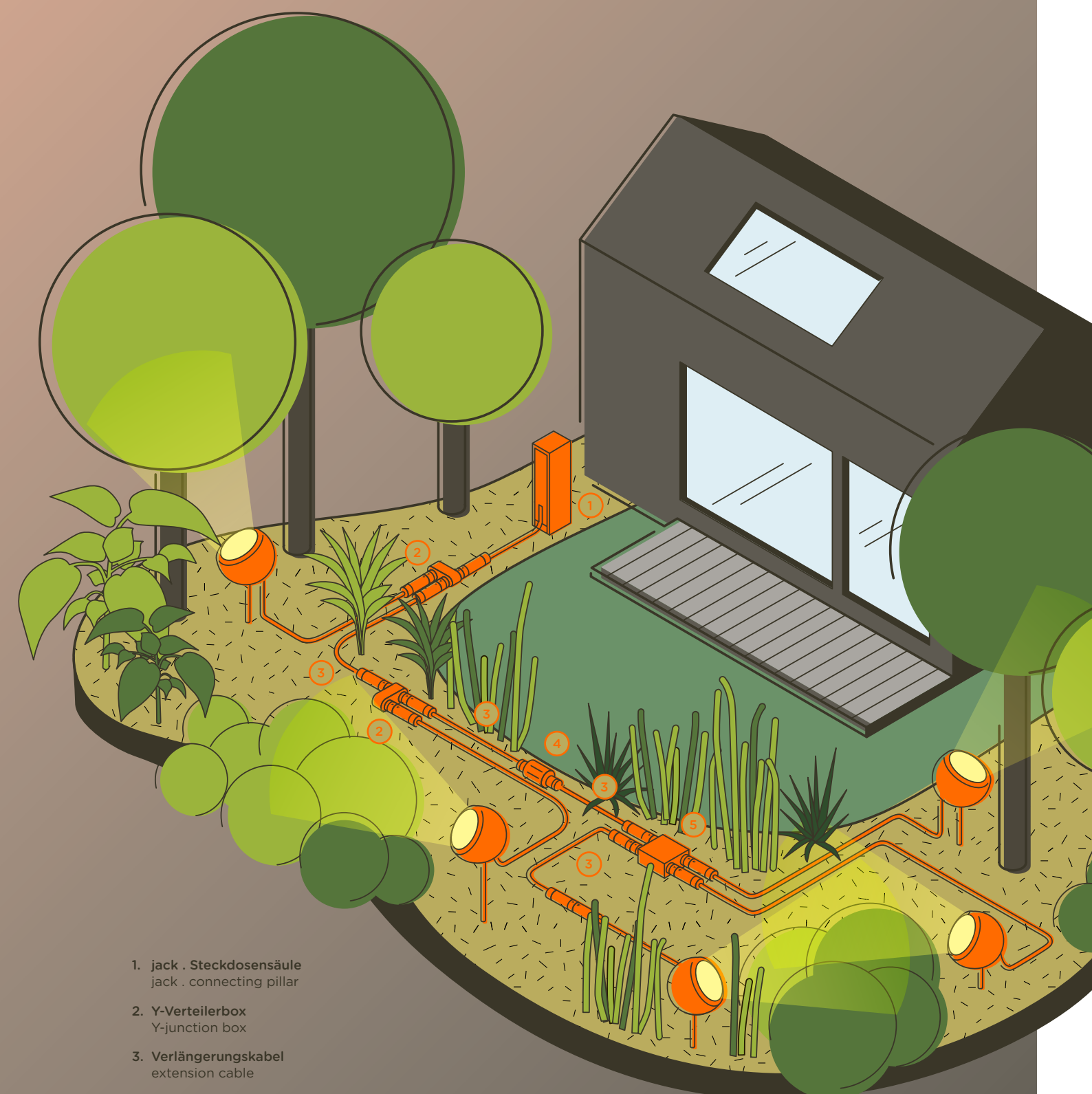

1. jack . Steckdosensäule  
jack . connecting pillar
2. Y-Verteilerbox  
Y-junction box
3. Verlängerungskabel  
extension cable
4. Controller (optional)  
controller (optional)
5. H-Verteilerbox  
H-junction box

# Vielfältig vernetzbar

## Versatile connectivity

Steckdose, Steckdosensäule oder Erdkabel? Bei der Vernetzung von IP44.DE connect gibt es für jedes Projekt den passenden Anschluss.  
Electrical socket, connecting pillar or underground cable? When it comes to connecting IP44.DE connect, we have the right solution for every project.

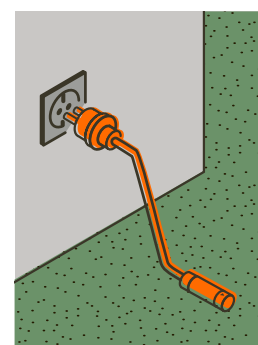

### 1. Energie aus der Steckdose energy from the electrical socket

Der schnellste Weg zum Licht im Garten oder auf dem Balkon: Einfach die Netz-Anschlussverbindung in die Steckdose stecken, beliebig viele Leuchten kombinieren – und fertig.

The fastest way to have light in the garden or on the balcony: simply plug the mains connection port into the electrical socket, combine as many luminaires as you want, and you're ready.

### 2. Netz-Anschluss über Steckdosensäule mains connection via connecting pillar

Über ein Erdkabel wird unkompliziert die Steckdosensäule jack mit Strom versorgt. Einfach Netz-Anschlussverbindung einstecken und Licht einschalten!

An underground cable is the straightforward way of supplying power to the connecting pillar jack. Simply plug in the mains connection port and switch the light on!

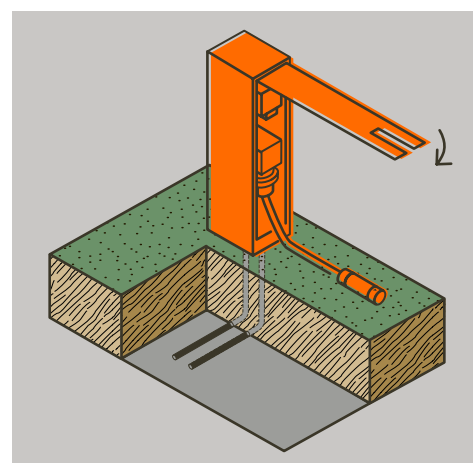

### 3. Einspeisung per Erd-Anschluss-Kit power feed with the underground connection kit

Die unauffälligste Art, ein IP44.DE connect-System netzseitig anzubinden: Über eine im Erd-Anschluss-Kit enthaltene Gießharzmuffe wird das System mit dem Erdkabel verbunden. Die Gießharzmuffe ist IP68 Schutzklassen-zertifiziert, korrosionsresistent und gewährleistet so über viele Jahre einen sicheren Anschluss ans Stromnetz.

The least conspicuous way to connect an IP44.DE connect system with the mains: the underground connection kit includes a cast resin sleeve to connect the system with the underground cable. The cast resin sleeve is certified to protection rating IP68 and is corrosion-resistant, thus warranting a reliable connection to the power supply that will last for many years.

# Robuste Verbindung

## Robust connection

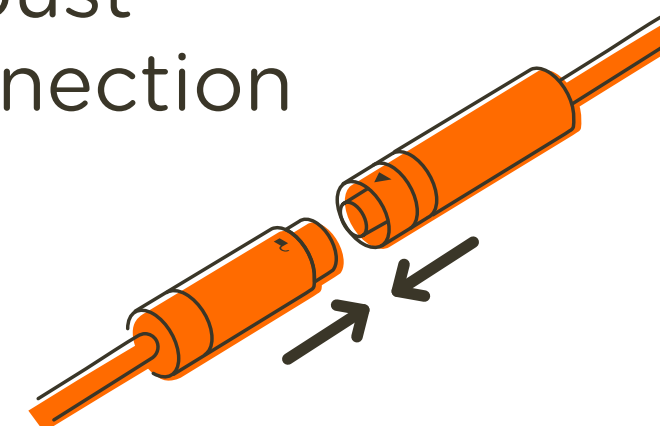

IP44.DE connect lässt sich eigenhändig installieren – keine Handwerkerunterstützung erforderlich!  
IP44.DE connect can be installed single-handed: no need for the help of a craftsman!

Im Außenbereich kommt es mehr als anderswo auf solide Verbindungen an, denen Wind und Wetter nichts anhaben können. Unser robustes TWISTLOCK-System kombiniert diese Hart-im-Nehmen-Qualitäten mit einem kinderleichten Stecksystem, das beim Verriegeln gleich Rückmeldung über die korrekte Endstellung gibt und somit Verlegefehler vermeidet.

Und so geht's: Durch den intelligenten TWISTLOCK-Mechanismus verrasten die Steckverbinder beim Zusammensetzen automatisch. Ein „Klick“-Geräusch verrät dem Nutzer, dass sich die Stecker sicher in der vorgesehenen Endstellung befinden. Soll das System verändert oder erweitert werden, lässt sich die Verbindung durch eine leichte Drehung wieder lösen.

Outside applications depend more than elsewhere on robust connections that are not affected by wind and weather. Our robust TWISTLOCK system combines these tough, resilient qualities with a foolproof plug-and-play system: once locked, it gives immediate feedback about the correct final position, thus avoiding installation errors.

This is how it works: the intelligent TWISTLOCK mechanism ensures the connectors lock automatically when they are put together. An audible click tells the user that the connectors are safely in the intended final position. A simple twist disconnects the elements again to change or extend the system.

### Einfaches Verbinden easy connection

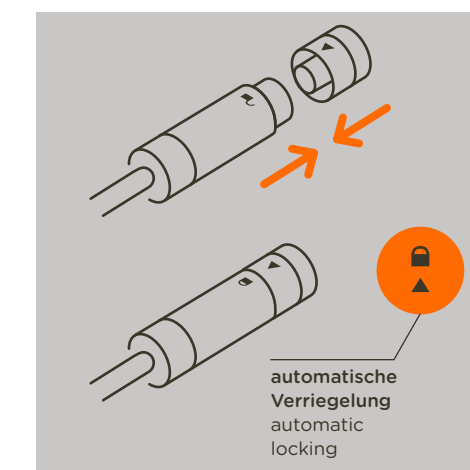

### Unkompliziertes Umbauen uncomplicated modification

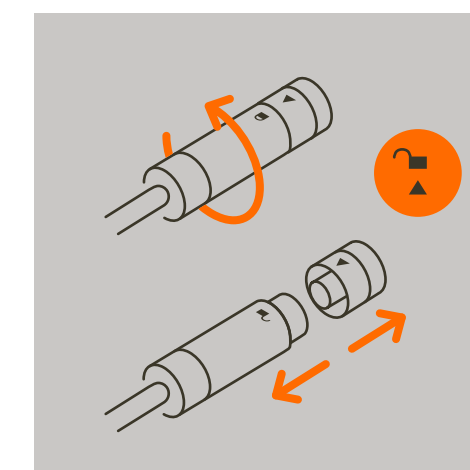



Spart Zeit und Mühe: Steckverbinder werden einfach und sicher verrastet.

Saves time and effort: connectors lock easily and safely.



# Komponenten und Zubehör

## Components and accessories



### 1. Netz-Anschlussverbindung mains connection port

Für den sicheren Anschluss ans Netz.  
Wahlweise zum Anschluss an eine  
Steckdose oder Steckdosensäule.

For a reliable connection to the mains.  
Can be connected to an electrical socket  
or connecting pillar.



### 2. Steckdosensäule jack connecting pillar jack

Die Alternative zum Erd- und Steckdosenanschluss: Oberirdische Zweifachsteckdose mit Erd-Anschluss-Anbindung.

The alternative to the underground connection and electrical socket: above-ground double socket with underground connection.

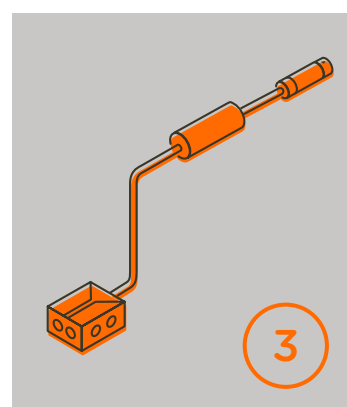

### 3. Erd-Anschluss-Kit underground connection kit

Verbindet das IP44.DE  
connect-System unauf-  
fällig und störungssicher  
mit dem Stromnetz.

Provides the IP44.DE  
connect system with  
an inconspicuous, trouble-  
free connection to the  
mains.



### 4. + 5. Y- und H-Verteilerbox Y- and H-junction box

Vernetzt 2 oder 3 Leuchten mit dem System – und  
ermöglicht die Bildung von Leuchtengruppen, die sich  
über den Controller (8.) gemeinsam ansteuern lassen.

Connects 2 or 3 luminaires with the system  
and can be used to set up luminaire groups that are controlled  
together by the same controller (8.).

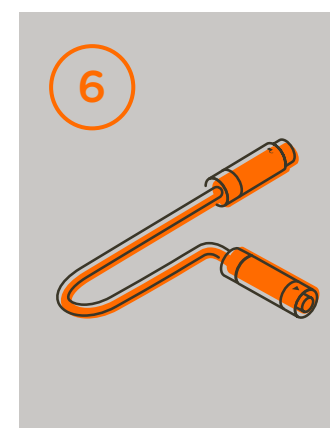

### 6. Verlängerungskabel extension cable

Wahlweise in 2, 5 oder  
10 Metern Länge zu haben  
– je nachdem, wie weit das  
System reichen soll.

Either 2, 5 or 10 metres  
in length, depending on  
the required range of the  
system.

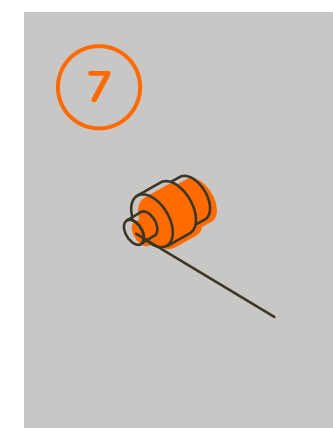

### 7. Verschlusskappe Buchse sealing cap socket

Verschließt unbelegte  
Buchsen.

Seals sockets that  
are not in use.

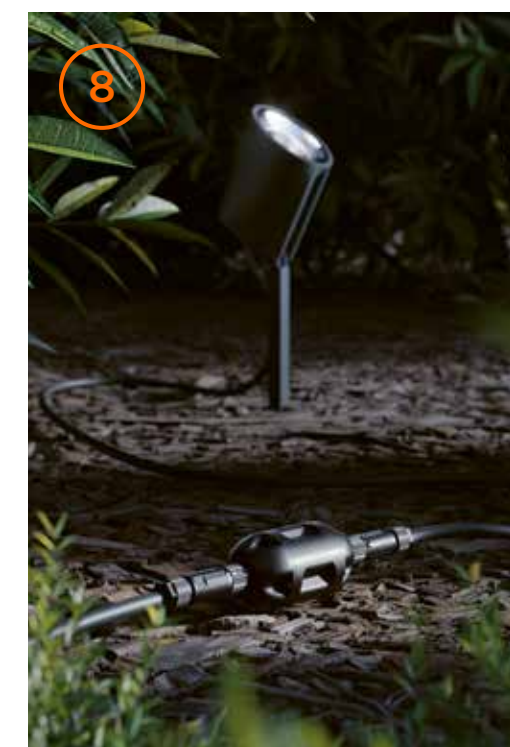

### 8. Controller controller

Über die kostenlose Casambi-App und  
Bluetooth Low Energy angesteuert, akti-  
viert und dimmt der Controller einzelne  
Leuchten oder vernetzte Leuchtengruppen.

The controller works via the free Casambi  
app and Bluetooth Low Energy to activate  
and dim individual luminaires or connected  
luminaire groups.

# Intelligent inszeniert

## Smart setting



Die Casambi-App gibt es zum kostenlosen Download im App/Play Store.

The Casambi app is available as a free download in the app/play store.



Schalten + Dimmen  
switching + dimming



Ansteuern von Einzelleuchten oder Leuchtengruppen  
actuating individual luminaires or groups of luminaires



Anwesenheit simulieren  
simulating presence



Lichtszene speichern + abspielen  
saving + playing light scenes



Timersteuerung  
timer control

Nur die smarten kommen in den Garten: Mit der kostenlosen Casambi-App lassen sich alle IP44.DE connect-Leuchten komfortabel per Smartphone oder Tablet steuern – und zwar sowohl einzelne Leuchten wie auch ganze Leuchtengruppen. Dafür wird der Controller ganz einfach über die Casambi-App – gibt es für iOS und Android – und Bluetooth Low Energy angesteuert und vor die jeweilige Lichtquelle gesteckt.

Mit einem Controller lassen sich sowohl einzelne Leuchten als auch ganze Leuchtengruppen steuern. Werden mehrere Controller angeschlossen, bildet sich ein durchgehendes Mesh-Netzwerk. Auf diese Weise sind bis zu 30 Meter Abstand von Controller zu Controller möglich – und damit eine Reichweite, auf die es im Außenbereich häufig ankommt. Mit IP44.DE connect lässt sich Außenlicht nicht nur auf Entfernung, sondern auch intelligent konfigurieren – und jederzeit flexibel neu kombinieren.

Smart gardens: the free Casambi app can be used for convenient control of all IP44.DE connect luminaires from your smartphone or tablet, either as individual luminaires or in whole luminaire groups. The Casambi app is available for iOS and Android, and works with Bluetooth Low Energy for simple actuation of the controller, which is positioned in front of the respective light source.

One controller can be used to control both individual luminaires and also whole luminaire groups. Several connectors can be connected up to produce a continuous mesh network. As a result, it is possible to have distances of up to 30 metres between the controllers, thus facilitating a range that is frequently required in outside contexts. IP44.DE connect permits remote, smart configuration of outdoor lighting while offering flexible scope for new combinations at any time.

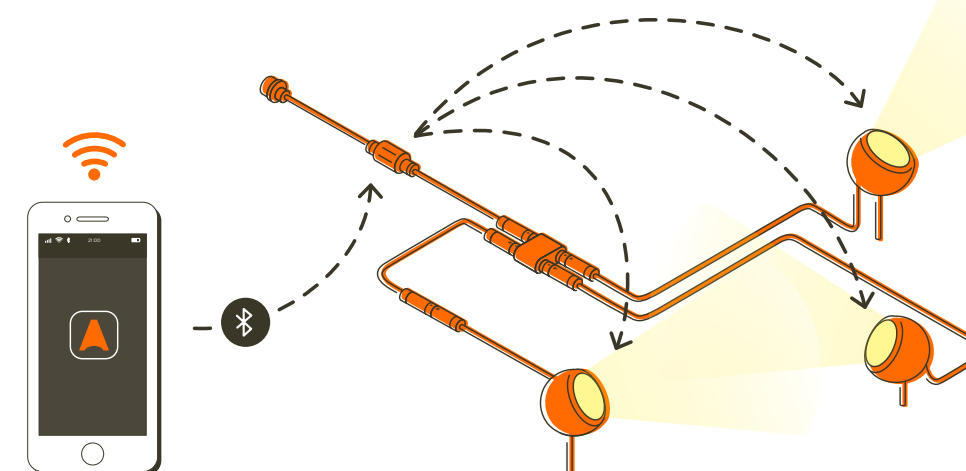



# IP44.DE connect Leuchten luminaires

Farbe colour      Art.-Nr. item no.      Systemleistung system performance

Anschluss: 5 m Zuleitung (H05RN8-F 3G0,75 mm<sup>2</sup>) inkl. connect Stecker  
 5 m Zuleitung auf Anfrage kürzbar  
 connection: 5 m supply cable (H05RN8-F 3G0,75 mm<sup>2</sup>) incl. connect plug  
 5 m supply cable can be shortened on request

## piek connect

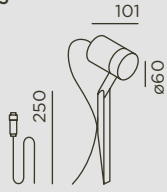
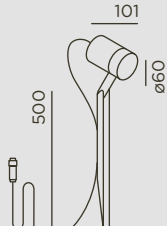
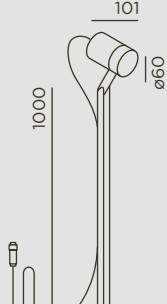
Modell	Farbe	Art.-Nr.	Systemleistung
piek 25 	anthracite RAL 7016	92071-27-AN-CO	6 W/220 lm
	cool brown	92071-27-CB-CO	6 W/220 lm
	deep black RAL 9005	92071-27-BL-CO	6 W/220 lm
piek 50 	anthracite RAL 7016	92070-27-AN-CO	6 W/220 lm
	cool brown	92070-27-CB-CO	6 W/220 lm
	deep black RAL 9005	92070-27-BL-CO	6 W/220 lm
piek 100 	anthracite RAL 7016	92072-27-AN-CO	6 W/220 lm
	cool brown	92072-27-CB-CO	6 W/220 lm
	deep black RAL 9005	92072-27-BL-CO	6 W/220 lm

+ Produktdetails Seite 268 product details page 268

Anschluss: 5 m Zuleitung (H05RN8-F 3G0,75 mm<sup>2</sup>) inkl. connect Stecker  
 5 m Zuleitung auf Anfrage kürzbar  
 connection: 5 m supply cable (H05RN8-F 3G0,75 mm<sup>2</sup>) incl. connect plug  
 5 m supply cable can be shortened on request

## piek lettura connect

Modell	Farbe	Art.-Nr.	Systemleistung
piek lettura connect 	anthracite RAL 7016	92075-27-AN-CO	6 W/220 lm
	cool brown	92075-27-CB-CO	6 W/220 lm
	deep black RAL 9005	92075-27-BL-CO	6 W/220 lm

+ Produktdetails Seite 276 product details page 276

Preise in separater Preisliste price in separate price list + [www.IP44.de](http://www.IP44.de)

Farbe colour	Art.-Nr. item no.	Systemleistung system performance
Anschluss: 5 m Zuleitung (H05RN-F 3G0,75 mm <sup>2</sup> ) inkl. connect Stecker 5 m Zuleitung auf Anfrage kürzbar connection: 5 m supply cable (H05RN-F 3G0,75 mm <sup>2</sup> ) incl. connect plug 5 m supply cable can be shortened on request		

## lin base connect

lin 40 base	Farbe colour	Art.-Nr. item no.	Systemleistung system performance
	anthracite RAL 7016	92093-27-AN-CO	9 W/164 lm
	cool brown	92093-27-CB-CO	9 W/164 lm
	deep black RAL 9005	92093-27-BL-CO	9 W/164 lm

lin 70 base	Farbe colour	Art.-Nr. item no.	Systemleistung system performance
	anthracite RAL 7016	92090-27-AN-CO	18 W/328 lm
	cool brown	92090-27-CB-CO	18 W/328 lm
	deep black RAL 9005	92090-27-BL-CO	18 W/328 lm

+ Produktdetails Seite 242 product details page 242

lin spike connect	Farbe colour	Art.-Nr. item no.	Systemleistung system performance
Anschluss: 5 m Zuleitung (H05RN-F 3G0,75 mm <sup>2</sup> ) inkl. connect Stecker 5 m Zuleitung auf Anfrage kürzbar connection: 5 m supply cable (H05RN-F 3G0,75 mm <sup>2</sup> ) incl. connect plug 5 m supply cable can be shortened on request			

lin 40 spike	Farbe colour	Art.-Nr. item no.	Systemleistung system performance
	anthracite RAL 7016	92094-27-AN-CO	9 W/164 lm
	cool brown	92094-27-CB-CO	9 W/164 lm
	deep black RAL 9005	92094-27-BL-CO	9 W/164 lm

lin 70 spike	Farbe colour	Art.-Nr. item no.	Systemleistung system performance
	anthracite RAL 7016	92091-27-AN-CO	18 W/328 lm
	cool brown	92091-27-CB-CO	18 W/328 lm
	deep black RAL 9005	92091-27-BL-CO	18 W/328 lm

Größe in mm  
size in mm + Produktdetails Seite 248 product details page 248

Preise in separater Preisliste prices in separate price list + [www.IP44.de](http://www.IP44.de)

Farbe colour	Art.-Nr. item no.	Systemleistung system performance
Anschluss: 5 m Zuleitung (H05RN8-F 3G0,75 mm <sup>2</sup> ) inkl. connect Stecker 5 m Zuleitung auf Anfrage kürzbar connection: 5 m supply cable (H05RN8-F 3G0,75 mm <sup>2</sup> ) incl. connect plug 5 m supply cable can be shortened on request		

## pad connect

pad connect	Farbe colour	Art.-Nr. item no.	Systemleistung system performance
	anthracite RAL 7016	91065-27-AN-CO	8 W/553 lm
	cool brown	91065-27-CB-CO	8 W/553 lm
	deep black RAL 9005	91065-27-BL-CO	8 W/553 lm

+ Produktdetails Seite 262 product details page 262

slat spike connect	Farbe colour	Art.-Nr. item no.	Systemleistung system performance
Anschluss: 5 m Zuleitung (H05RN8-F 3G0,75 mm <sup>2</sup> ) inkl. connect Stecker 5 m Zuleitung auf Anfrage kürzbar connection: 5 m supply cable (H05RN8-F 3G0,75 mm <sup>2</sup> ) incl. connect plug 5 m supply cable can be shortened on request			

slat spike connect	Farbe colour	Art.-Nr. item no.	Systemleistung system performance
	anthracite RAL 7016	91030-27-AN-CO	8 W/280 lm
	cool brown	91030-27-CB-CO	8 W/280 lm
	deep black RAL 9005	91030-27-BL-CO	8 W/280 lm

+ Produktdetails Seite 302 product details page 302









stic spike connect	Farbe colour	Art.-Nr. item no.	Systemleistung system performance
Anschluss: 5 m Zuleitung (H05RN8-F 3G0,75 mm <sup>2</sup> ) inkl. connect Stecker 5 m Zuleitung auf Anfrage kürzbar connection: 5 m supply cable (H05RN8-F 3G0,75 mm <sup>2</sup> ) incl. connect plug 5 m supply cable can be shortened on request			

stic 30 spike	Farbe colour	Art.-Nr. item no.	Systemleistung system performance
	anthracite RAL 7016	91061-27-AN-CO	8 W/559 lm
	cool brown	91061-27-CB-CO	8 W/559 lm
	deep black RAL 9005	91061-27-BL-CO	8 W/559 lm

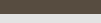
stic 70 spike	Farbe colour	Art.-Nr. item no.	Systemleistung system performance
	anthracite RAL 7016	91060-27-AN-CO	8 W/559 lm
	cool brown	91060-27-CB-CO	8 W/559 lm
	deep black RAL 9005	91060-27-BL-CO	8 W/559 lm

Größe in mm  
size in mm + Produktdetails Seite 310 product details page 310

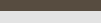
Preise in separater Preisliste price in separate price list + [www.IP44.de](http://www.IP44.de)





	Farbe colour	Art.-Nr. item no.	Systemleistung system performance	
<b>shot connect</b>				
Anschluss: 5 m Zuleitung (H05RN8-F 3G0,75 mm <sup>2</sup> ) inkl. connect Stecker 5 m Zuleitung auf Anfrage kürzbar connection: 5 m supply cable (H05RN8-F 3G0,75 mm <sup>2</sup> ) incl. connect plug 5 m supply cable can be shortened on request				
shot 4 W 		anthracite RAL 7016	91090-27-4W-AN-CO	4 W/219 lm
		cool brown	91090-27-4W-CB-CO	4 W/219 lm
		deep black RAL 9005	91090-27-4W-BL-CO	4 W/219 lm
shot 15 W 		anthracite RAL 7016	91090-27-15W-AN-CO	15 W/874 lm
		cool brown	91090-27-15W-CB-CO	15 W/874 lm
		deep black RAL 9005	91090-27-15W-BL-CO	15 W/874 lm
+ Produktdetails Seite 286 product details page 286				

### Erforderliches Zubehör required accessory

für festen Untergrund for solid ground

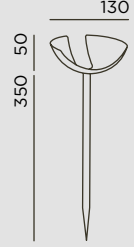
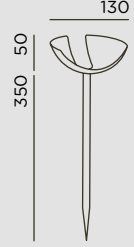

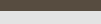

shot ring 	Farbe colour	Art.-Nr. item no.	Material material	
		anthracite RAL 7016	91090-R-AN	Aluminiumguss pulverbeschichtet aluminium die-casting powder-coated
		cool brown	91090-R-CB	Aluminiumguss pulverbeschichtet aluminium die-casting powder-coated
		deep black RAL 9005	91090-R-BL	Aluminiumguss pulverbeschichtet aluminium die-casting powder-coated

für unbefestigte Beet- und Grünflächen for unpaved beds and greens

shot tee 	Farbe colour	Art.-Nr. item no.	Material material	
		anthracite RAL 7016	91091-AN	Schale: Aluminiumguss pulverbeschichtet Stab: Edelstahl pulverbeschichtet bowl: aluminium die-casting powder-coated pole: stainless steel powder-coated
		cool brown	91091-CB	Schale: Aluminiumguss pulverbeschichtet Stab: Edelstahl pulverbeschichtet bowl: aluminium die-casting powder-coated pole: stainless steel powder-coated
		deep black RAL 9005	91091-BL	Schale: Aluminiumguss pulverbeschichtet Stab: Edelstahl pulverbeschichtet bowl: aluminium die-casting powder-coated pole: stainless steel powder-coated

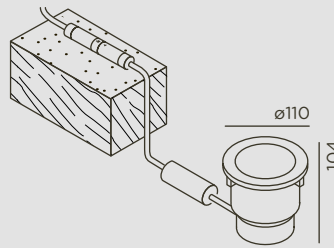
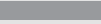
Größe in mm  
size in mm

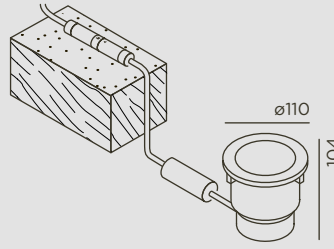
Preise in separater Preisliste prices in separate price list + [www.IP44.de](http://www.IP44.de)

	Farbe colour	Art.-Nr. item no.	Systemleistung system performance	
<b>in A + in S connect</b>				
Anschluss: 2 m Zuleitung (H05RN8-F 3G0,75 mm <sup>2</sup> ) mit Aquastop; inkl. connect Stecker connection: 2 m supply cable (H05RN8-F 3G0,75 mm <sup>2</sup> ) with aquastop; incl. connect plug				
in A 		stainless steel Sicherheits- glas klar safety glass clear	91081-27-CO	8 W/ 539 lm
		stainless steel black galvanisiert Sicherheitsglas getönt galvanized safety glass tinted	91081-27-BL-CO	8 W/238 lm
+ Produktdetails Seite 238 product details page 238				
in S 		stainless steel Sicherheitsglas klar safety glass clear	91080-27-CO	8 W/574 lm
		stainless steel black galvanisiert Sicherheitsglas getönt galvanized safety glass tinted	91080-27-BL-CO	8 W/261 lm
+ Produktdetails Seite 240 product details page 240				

Preise in separater Preisliste price in separate price list + [www.IP44.de](http://www.IP44.de)

# IP44.DE connect Zubehör accessory

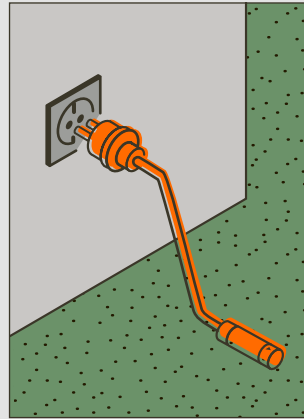

**Netz-Anschlussverbindung**  
mains connection port

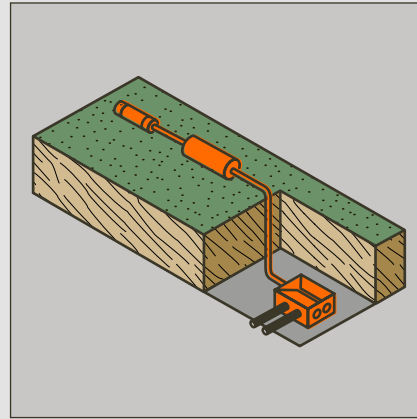

**Erd-Anschluss-Kit**  
underground connection kit

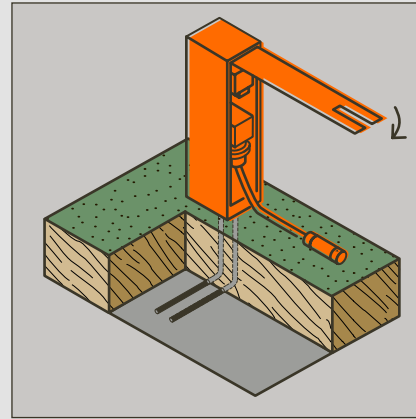



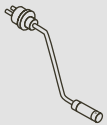
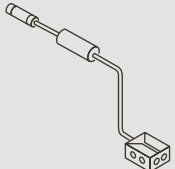
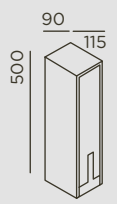

**jack . Steckdosensäule**  
jack . connecting pillar

Zubehör accessory	Artikel article	Art.-Nr. item no.
	<b>5 m Netz-Anschlussverbindung</b> 5 m mains connection port  <b>Schutzkontaktstecker auf connect Buchse</b> Kabel: H07RN-F 3G1,5 mm <sup>2</sup> Schutzart: IP44 safety plug on connect socket cable: H07RN-F 3G1,5 mm <sup>2</sup> protection class: IP44	55100
	<b>Erd-Anschluss-Kit</b> underground connection kit  <b>2 m Anschlussverbindung mit connect Buchse, Aquastop und offenem Kabelende</b> Erdkabel: H05RN8-F 3G0,75 mm <sup>2</sup>  <b>Erd-Abzweigkasten inkl. Anschlussklemme + Gießharz:</b> Installation: 7x Kabeleinführung; Anschlussklemme 5x 2,5 mm <sup>2</sup> Schutzart: IP65 2 m connection port with connect socket, aquastop and open cable end underground cable: H05RN8-F 3G0,75 mm <sup>2</sup>  earth distribution box incl. connection terminal+cast resin: installation: 7x cable entry point; connection terminal 5x 2,5 mm <sup>2</sup> protection class: IP65	55202
	<b>jack . Steckdosensäule</b> jack . connecting pillar  inkl. 2x Schutzkontaktsteckdosen (belgische-/französische + Schweizer Norm möglich) Installation: Anschlussklemme 5x 1,5 mm <sup>2</sup> ; Durchgangsverdrahtung mit Y-Verbinder in der Säule möglich Montage: Bauseitiges Fundament oder befestigter Untergrund Material: Aluminiumguss pulverbeschichtet Schutzart: IP54  incl. 2x safety sockets (Belgian/French + Swiss norm possible) installation: connection terminal 5x 1,5 mm <sup>2</sup> ; possibility of through wiring with Y-connector inside pillar assembly: on site foundation or solid ground material: aluminium die-casting powder-coated protection class: IP54	<b>EUR-norm</b> 55090-AN 55090-CB 55090-BL  <b>BE+FR-norm</b> 55090-BEFR-AN 55090-BEFR-CB 55090-BEFR-BL  <b>CH-norm</b> 55090-CH-AN 55090-CH-CB 55090-CH-BL

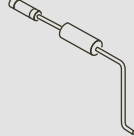
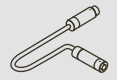
Größe in mm  
size in mm

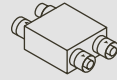
Preise in separater Preisliste . prices in separate price list + [www.IP44.de](http://www.IP44.de)

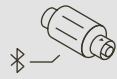
Zubehör accessory	Artikel article	Art.-Nr. item no.
	<b>Erd-Anschlussverbindung</b> earth connection port  <b>2 m Erd-Anschlussverbindung mit connect-Buchse, Aquastop und offenem Kabelende</b> Erdkabel: H05RN8-F 3G0,75 mm <sup>2</sup> Schutzart: IP65 2 m earth connection port with connect socket, aquastop and open cable end underground cable: H05RN8-F 3G0,75 mm <sup>2</sup> protection class: IP65	55112
	<b>Verlängerungskabel</b> extension cable  <b>connect Stecker auf connect Buchse</b> Kabel: H07RN-F 3G1,5 mm <sup>2</sup> Schutzart: IP65 connect plug on connect socket cable: H07RN-F 3G1,5 mm <sup>2</sup> protection class: IP65	2 m 55102 5 m 55105 10 m 55110
	<b>Sonderlängen auf Anfrage</b> special lengths on request	
	<b>Y-Verteilerbox</b> Y-junction box  <b>1x connect Stecker, 2x connect Buchse</b> Schutzart: IP65 1x connect plug, 2x connect socket protection class: IP65	55122
	<b>H-Verteilerbox</b> H-junction box  <b>1x connect Stecker, 3x connect Buchse</b> Schutzart: IP65 1x connect plug, 3x connect socket protection class: IP65	55123
	<b>Verschlusskappe Buchse</b> sealing cap socket	55192
	<b>Controller</b> controller  Kompatibilität: Casambi Ein- und Ausgangsspannung: 230V max. Ausgangsleistung: 150 W Übertragungreichweite: 30 m (freies Gelände) Schutzart: IP65 compatibility: Casambi in- and output voltage: 230V max. output power: 150 W transmission range: 30 m (free area) protection class: IP65	55400

Preise in separater Preisliste . prices in separate price list + [www.IP44.de](http://www.IP44.de)

solar join

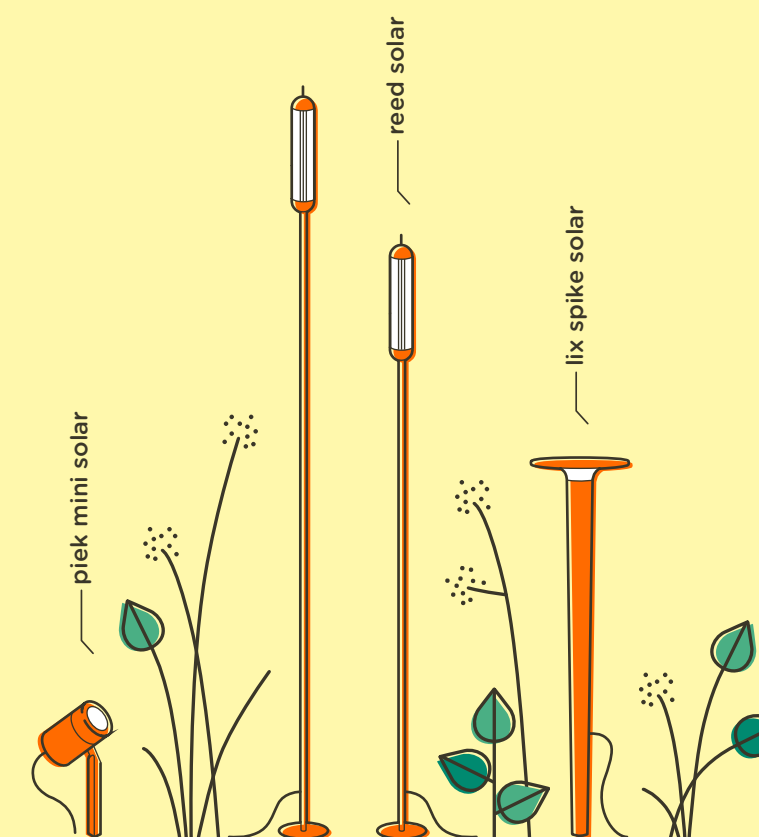

## Einfach einleuchtend Simply illuminating

Mit IP44.DE solar join eröffnen wir ein ganz neues Kapitel in der Außenbeleuchtung. Als Kombination von bis zu vier Solarleuchten mit einem leistungsstarken Solarpanel lassen sich mit ihm absolut autarke Lichtinseln schaffen – ganz ohne externen Stromanschluss und konventionellen Energieverbrauch. Dabei können alle IP44.DE solar join Leuchtenmodelle kombiniert und damit ganz unterschiedlichste Lichtstimmungen geschaffen werden. Bei Licht betrachtet, bildet IP44.DE solar join damit die denkbar einfachste wie auch ressourcenschonendste Beleuchtungslösung für Gärten, Dachterrassen und Balkone.

IP44.DE solar join opens a completely new chapter in outside lighting. In combination with up to four solar luminaires and a powerful solar panel, IP44.DE solar join can be used to create absolutely self-sufficient light islands, without any external power connection or conventional energy consumption. Combinations are possible with all IP44.DE solar join luminaire models for completely different light moods. Seen in the light of day, IP44.DE solar join is thus conceivably the easiest and most resource-efficient lighting solution for gardens, roof patios and balconies.





Starke Verbindung:  
Wo Licht gefragt,  
aber ein Stroman-  
schluss fern ist, spielt  
IP44.DE solar join  
seine Stärken aus.

Strong connection:  
IP44.DE solar join  
comes into its own in  
situations where light  
is wanted but the next  
power socket is too  
far away.

# 100% klimapositiv 100% climate-positive

IP44.DE solar join speichert das Licht des Tages für die Stunden der Nacht. Bei Dämmerung schaltet sich das System selbsttätig ein und spätestens nach fünf Stunden wieder aus. Das heißt aber auch: Unser Leuchtencluster spendet immer nur so viel Licht, wie es zuvor an Sonnenenergie einsammeln und speichern konnte. In der dunkleren Jahreszeit, bei niedrigem Sonnenstand und nach Schlechtwetterphasen sinkt die Leuchtdauer naturgemäß. Mit höherem Sonnenstand und mehr Sonnenstunden kehrt sie wieder zu alter Stärke zurück.

IP44.DE solar join stores daytime light for nighttime hours. The system comes on automatically at twilight and goes off again at the latest five hours later. This also means our luminaire cluster never sheds more light than the amount of solar energy previously collected and stored. During the darker seasons, when the sun is low and after bad weather, the burn time is naturally less. But it is restored to full strength when the sun is higher in the sky and when there are more hours of sunshine.

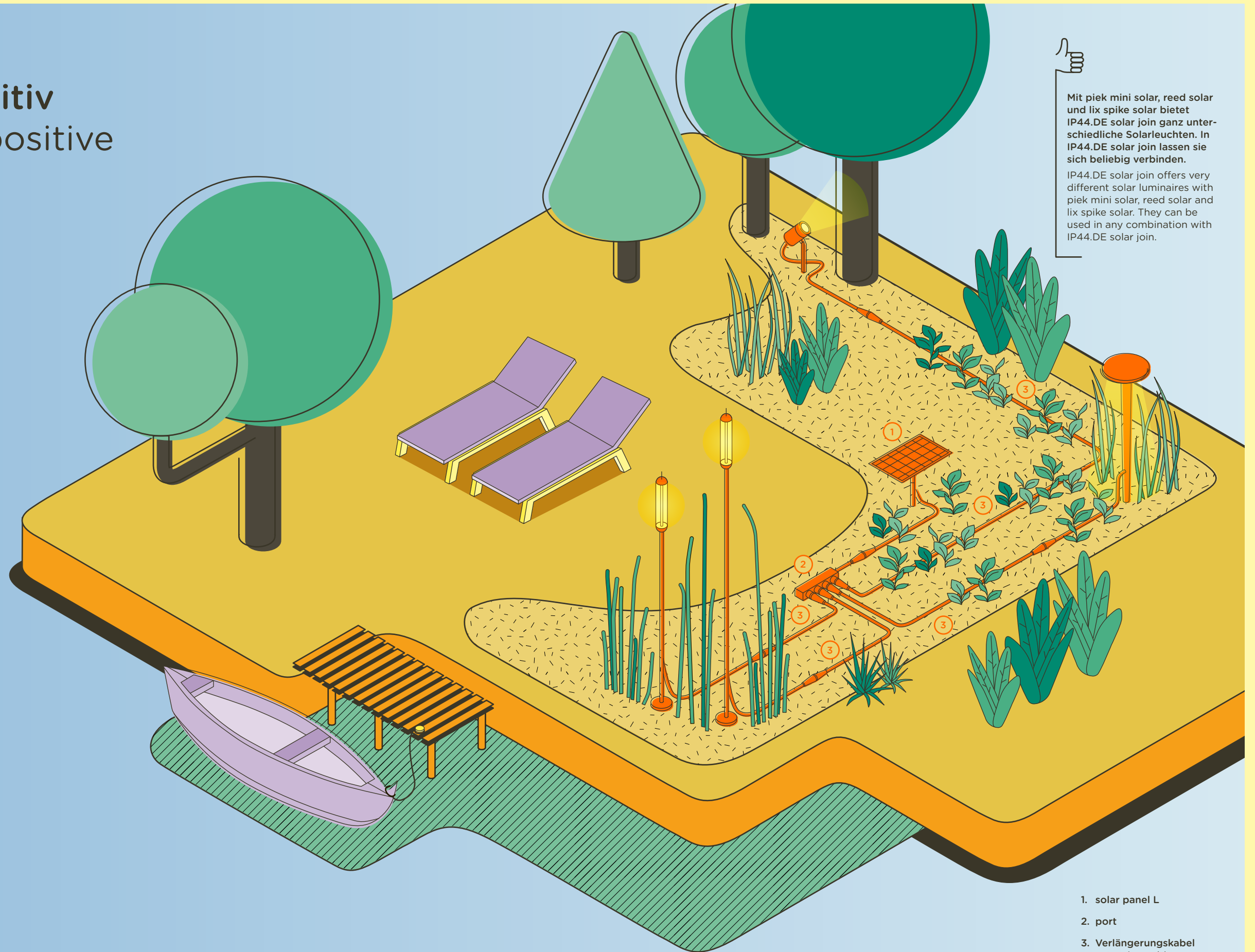

Mit piek mini solar, reed solar und lix spike solar bietet IP44.DE solar join ganz unterschiedliche Solarleuchten. In IP44.DE solar join lassen sie sich beliebig verbinden.

IP44.DE solar join offers very different solar luminaires with piek mini solar, reed solar and lix spike solar. They can be used in any combination with IP44.DE solar join.

1. solar panel L
2. port
3. Verlängerungskabel  
extension cable

# Komponenten und Konfiguration

## Components and configuration



### 1. solar panel L

Herzstück jedes IP44.DE solar join-Systems ist das solar panel L. Mit seiner großzügigen 22,5 x 22,5 cm Fläche fängt es jede Menge Sonne ein und speichert sie in einem leistungsstarken Akku. Per Kippgelenk lässt es sich auf den aktuellen Sonnenstand ausrichten.

The heart of every IP44.DE solar join system is the solar panel L. With its generous size of 22.5 x 22.5 cm, it captures lots of sunlight which is stored in a powerful battery. The articulated joint means it can be aligned to the current level of the sun.

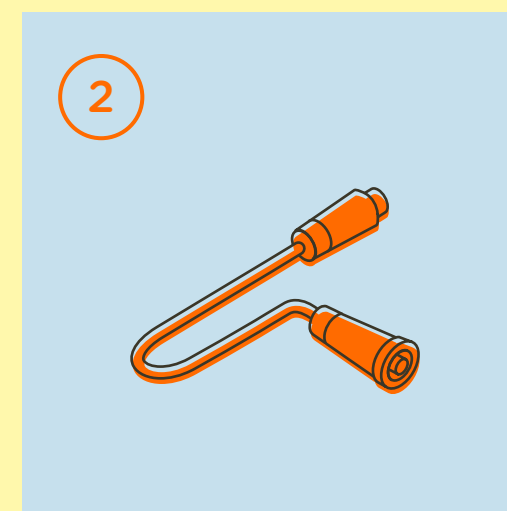

### 2. Verlängerungskabel extension cable

Mit ihm lassen sich die Verbindung zwischen port und solar panel L oder port und Solarleuchten verlängern. Zu haben in 2, 4 oder 8 Metern Länge.

The extension cable makes it possible to extend the connection between port and solar panel L or port and solar luminaire. Available in lengths of 2, 4 or 8 metres.



### 3. port

Verbindet solar panel L und Leuchten; verfügbar als port 2, port 3 und port 4 (jeweils 1 Stecker + 2/3/4 Buchsen).

Connects the solar panel L and luminaires; available as port 2, port 3 and port 4 (each with 1 plug + 2/3/4 sockets).

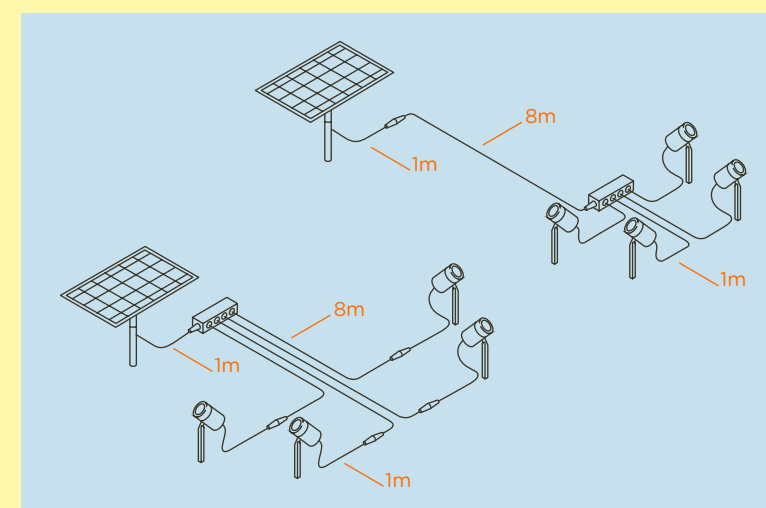

### Verlängerungsvarianten extension variants

Um Leistungsverluste zu vermeiden, sollte der Abstand zwischen solar panel L und Leuchte 10 Meter nicht überschreiten.

The distance between solar panel L and luminaire should not exceed 10 metres to avoid power losses.

# Tipps für maximale Sonnenernte

## Tips for maximum solar harvest

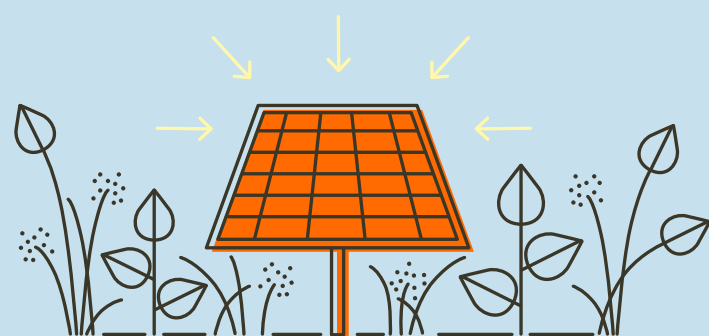

### Ideale Platzierung ideal placement

Damit das solar panel L jeden Sonnenstrahl einfangen kann, sollte es so platziert werden, dass es nicht von Blättern, Zweigen oder Bäumen verschattet wird.

To ensure solar panel L can capture every ray of sunshine, it should be put in a place where it is not overshadowed by leaves, twigs or trees.

### Jahreszeitliche Ausrichtung seasonal alignment

Die meiste Energie sammelt das Panel, wenn die Sonnenstrahlen im 90°-Winkel einfallen. Deshalb ist der Standort des Solarpanels dem jahreszeitlich verändernden Sonnenstand anzupassen.

The panel collects the most energy when sun beams hit it at an angle of 90°. The place where the solar panel is put should therefore be adjusted to the level of the sun in the sky, which changes according to the season.

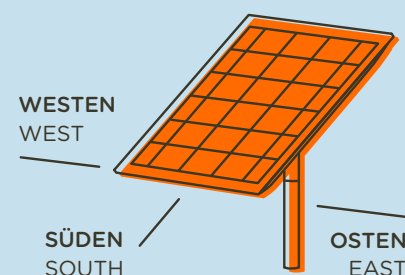
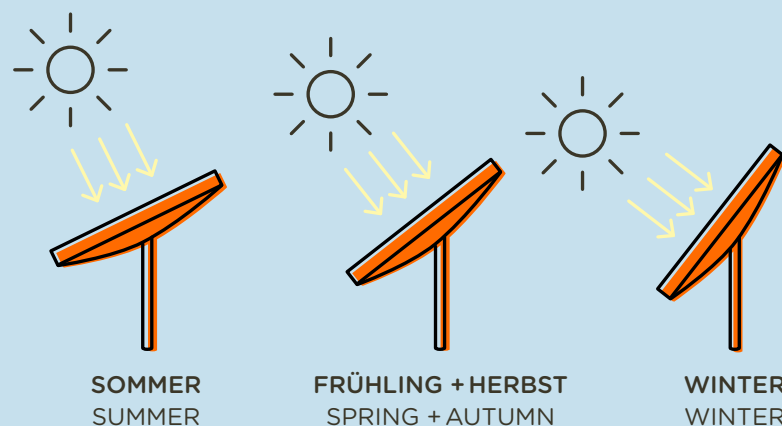

### Perfekte Positionierung perfect positioning

Wo die Sonne am höchsten steht, spendet sie auch am meisten Energie. Deshalb: Das Solarpanel möglichst direkt gen Süden ausrichten!

The sun provides the most energy at its highest point in the sky. That is why the solar panel should be aligned directly to the south, as far as possible.



### Regelmäßige Reinigung regular cleaning

Blätter, Ablagerungen oder Schmutz mit einem Tuch und Wasser beseitigen.

Remove leaves, debris or dirt with a cloth and water.

# Wissenswertes zu IP44.DE solar join

## Useful information about IP44.DE solar join



### Volle Power full power

Zwei Sonnentage à zehn Stunden in Südausrichtung reichen aus, um das solar panel L vollständig zu laden. Ein komplett geladener Akku gibt Kraft für 15 Stunden Licht, also etwa drei Abende stimmungsvoller Beleuchtung.

Two sunny days with ten hours aligned in a southerly direction are sufficient to fully charge the solar panel L. A completely charged battery has enough power for 15 hours of light, in other words, approx. three evenings of atmospheric lighting.



### Leuchten mit der Natur luminaires and nature

Je tiefer der Sonnenstand und je kürzer die Sonnenscheindauer, umso weniger PV-Energie kann das solar panel L einsammeln. IP44.DE solar join leistet daher in der helleren Jahreszeit deutlich mehr als in der dunklen.

The lower the level of the sun in the sky and the shorter the hours of sunshine, the smaller the amount of PV energy collected by the solar panel L. IP44.DE solar join therefore has a far greater output during the brighter months of the year than in the dark seasons.

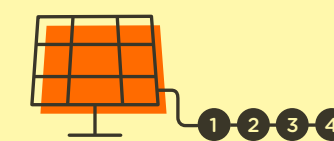

### Vier gewinnt connect four

Bis zu vier Solarleuchten lassen sich über den port mit einem solar panel L koppeln. Ein zweites Solarpanel hingegen lässt sich nicht anschließen.

The port can be used to connect up to four solar luminaires to one solar panel L. On the other hand, it is not possible to connect a second solar panel.



### Automatikmodus automatic mode

Ist der Akku geladen, schaltet sich das System IP44.DE solar join bei Einbruch der Dunkelheit automatisch ein - und nach etwa fünf Stunden selbsttätig wieder aus. Bis zum nächsten Recharging überbrückt der Akku problemlos auch drei Tage ohne Sonnenschein.

When the battery is fully charged, the IP44.DE solar join system goes on automatically when it starts to get dark - and goes off again automatically after about five hours. The battery can also easily bridge three days without sunshine before being recharged again.

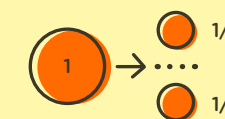

### Geteilte Leistung shared output

Die Leistung des solar panel L verteilt sich gleichmäßig auf die im IP44.DE solar join-Netzwerk angeschlossenen Leuchten. Sie ist allerdings so stark angelegt, dass selbst bei vier angeschlossenen Leuchten immer noch in etwa dieselbe Leistung erreicht wird, wie bei einer Solitärleuchte in Kombination mit dem solar panel S.

The output of the solar panel L is shared equally among the luminaires connected to the IP44.DE solar join network. And even when four luminaires are connected, the system is so strong that the output is still approx. the same as with one solitary luminaire in combination with the solar panel S.

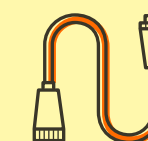

### Maximale Entfernung maximum distance

Sowohl unsere Solarleuchten als auch das solar panel L sind mit einem je etwa 1 Meter langem Kabel ausgestattet. Mit einem 8 Meter Verlängerungskabel lässt sich die Entfernung zwischen beiden auf 10 Meter verlängern - größer sollte die Distanz auch nicht sein.

Both our solar luminaires and also the solar panel L are each equipped with a cable about 1 metre long. An 8 metres extension cable can be used to extend the distance between luminaire and solar panel to 10 metres. The distance should not be any larger than this.



# IP44.DE solar join Leuchten luminaires

Farbe colour	Art.-Nr. item no.	Systemleistung system performance
-----------------	----------------------	--------------------------------------

## lix spike solar join

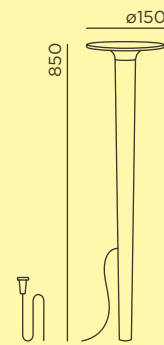
Anschluss: 0,8 m Zuleitung (H05RN8-F 2x0,75 mm<sup>2</sup>) inkl. solar join Stecker  
connection: 0,8 m supply cable (H05RN8-F 2x0,75 mm<sup>2</sup>) incl. solar join plug







 anthracite RAL 7016	93093-AN-JO	4,4 W/260 lm 1x lix spike solar join	-	1,1 W/65 lm 4x lix spike solar join
 cool brown	93093-CB-JO	4,4 W/260 lm 1x lix spike solar join	-	1,1 W/65 lm 4x lix spike solar join
 deep black RAL 9005	93093-BL-JO	4,4 W/260 lm 1x lix spike solar join	-	1,1 W/65 lm 4x lix spike solar join

+ Produktdetails Seite 58 product details page 58

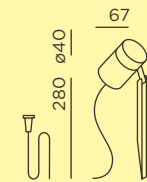
## piek mini solar join

Anschluss: 1 m Zuleitung (H05RN8-F 2x0,75 mm<sup>2</sup>) inkl. solar join Stecker  
connection: 1 m supply cable (H05RN8-F 2x0,75 mm<sup>2</sup>) incl. solar join plug





 anthracite RAL 7016	93076-AN-JO	4 W/240 lm 1x piek mini solar join	-	1 W/60 lm 4x piek mini solar join
 cool brown	93076-CB-JO	4 W/240 lm 1x piek mini solar join	-	1 W/60 lm 4x piek mini solar join
 deep black RAL 9005	93076-BL-JO	4 W/240 lm 1x piek mini solar join	-	1 W/60 lm 4x piek mini solar join

+ Produktdetails Seite 64 product details page 64

## reed solar join

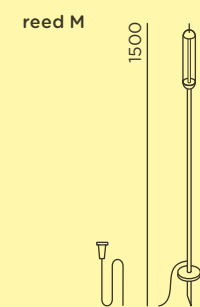
Anschluss: 1,4 m (reed M)/1,2 m (reed L) Zuleitung (H05RN8-F 2x0,75 mm<sup>2</sup>) inkl. solar join Stecker  
connection: 1,4 m (reed M)/1,2 m (reed L) supply cable (H05RN8-F 2x0,75 mm<sup>2</sup>) incl. solar join plug



 deep black RAL 9005	93821-BL-JO	4 W/64 lm 1x reed solar join	-	1 W/16 lm 4x reed solar join
--	-------------	---------------------------------	---	---------------------------------

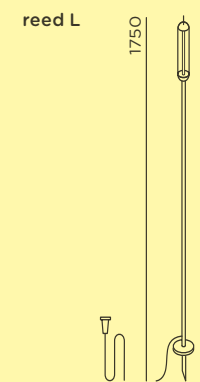

 deep black RAL 9005	93822-BL-JO	4 W/64 lm 1x reed solar join	-	1 W/16 lm 4x reed solar join
--	-------------	---------------------------------	---	---------------------------------

Größe in mm  
size in mm

+ Produktdetails Seite 74 product details page 74

Preise in separater Preisliste price in separate price list + [www.IP44.de](http://www.IP44.de)

# IP44.DE solar join Zubehör accessory

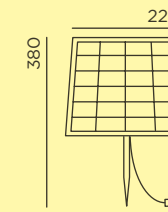

Erforderliches Zubehör required accessory

solar panel L



Größe in mm  
size in mm

Solarpanel  
Lithium-Ionen Akku  
4x 2600 mAh  
1 m Zuleitung (H05RN8-F 2x0,75 mm<sup>2</sup>)  
Schutzart: IP65  
solar panel  
lithium-ion battery  
4x 2600 mAh  
1 m supply cable (H05RN8-F 2x0,75 mm<sup>2</sup>)  
protection class: IP65

Farbe colour	Art.-Nr. item no.
 anthracite RAL 7016	53110-AN
 cool brown	53110-CB
 deep black RAL 9005	53110-BL

Optionales Zubehör optional accessory

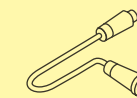

Verlängerungskabel  
extension cable

solar join Stecker auf solar join Buchse  
Kabel: H05RN8-F 2x0,75 mm<sup>2</sup>  
Schutzart: IP68  
solar join plug on solar join socket  
cable: H05RN8-F 2x0,75 mm<sup>2</sup>  
protection class: IP68

2 m	53102
4 m	53104
8 m	53108

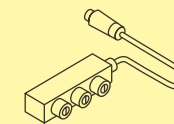

Verteiler  
junction

1x solar join Stecker; 2x/3x/4x solar join Buchse  
Kabel: H05RN8-F 2x0,75 mm<sup>2</sup>  
Schutzart: IP68  
1x solar join plug; 2x/3x/4x solar join socket  
cable: H05RN8-F 2x0,75 mm<sup>2</sup>  
protection class: IP68

port 2	53122
port 3	53123
port 4	53124

Preise in separater Preisliste price in separate price list + [www.IP44.de](http://www.IP44.de)

# Wissenswertes useful information

## Einsatzbereiche application areas

Keine Umgebung ist wie die andere, und genauso wenig sind es die Materialeigenschaften unserer Leuchten. Sollten Sie den Einsatz unserer Produkte in Meeresnähe oder der Umgebung eines Swimmingpools planen, wenden Sie sich bitte an uns. Durch Salz- bzw. Chlorpartikel in der Luft würden die Oberflächen unserer Leuchten überdurchschnittlich beansprucht werden.

All environments differ. The same goes for the material properties of our luminaires. Please consult us if you intend to use our products near the coast or in the vicinity of a swimming pool. Salt or chlorine particles in the air would make life very difficult for our luminaires.

## Kondenswasser condensation

In Phasen hoher Luftfeuchtigkeit und starker Temperaturunterschiede – üblicherweise im Frühjahr und Herbst – kann sich im Glasgehäuse Kondenswasser absetzen. Dies ist kein Zeichen mangelnder Qualität, sondern eine natürliche Folge der physikalischen Wassereigenschaften. Abhilfe schaffen Sie ganz einfach, indem Sie die Leuchte einmal längere Zeit eingeschaltet und das Kondensat austrocknen lassen.

High humidity levels or great fluctuations in temperature, climatic conditions which normally occur in spring and autumn, can cause condensation in the glass housing. This does not indicate a flaw in the product but is a natural consequence of the physical properties of water. The best way to deal with condensation is simply to leave the luminaire switched on for a while so that the condensation can dry out.

## Pflege und Oberflächen caring and surfaces

Unsere Leuchten haben wir so ausgelegt, dass sie viele Jahre lang ihren Dienst tun. Damit sie über all diese Jahre nichts von ihrer Attraktivität einbüßen und Sie lange Freude an Ihren Leuchten haben, sind wir ein wenig auf Ihre Mithilfe angewiesen: Bitte reinigen Sie Ihre Leuchten regelmäßig. Ein sanfter, lösungsmittelfreier Haushaltsreiniger ist für die Pflege völlig ausreichend. Scheuermittel, Stahlwolle, Säuren oder alkalische Reinigungsmittel hingegen würden ihre Oberfläche beschädigen.

Our luminaires have been designed to do their job for many years. But we need a little help from you to make sure that they don't lose their looks as the years go by and that they will continue to bring you pleasure for a long time. Please clean your IP44.DE luminaires regularly. A gentle, solvent-free household cleaner is all that's needed to care for the luminaire. Abrasive cleaners, steel wool, acids or alkali cleaning agents should not be used as these would damage the surface.

Unsere Aluminiumguss-Leuchten verfügen über eine Pulverlack-Oberfläche von hoher chemischer und mechanischer Beständigkeit. Wie bei jeder Oberfläche, kann es auch hier zu einer Veränderung des Farbtons durch UV-Strahlen (z.B. Sonnenlicht) kommen. Unter dem Einfluss des UV-Lichts kann es zu einer Veränderung der im Pulverlack eingebetteten Farbpigmente kommen.

Our aluminium die-casting luminaires have a powder-coated finish that offers high chemical and mechanical resistance. As with every surface, the colour shade of our powder-coated surfaces can also be changed when exposed to UV radiation (e.g. sunlight). Exposure to UV light can cause changes to the colour pigments embedded in the powder coating.

Edelstahl verfügt über eine einzigartige Eigenschaft: Wird er beschädigt, verschließt sich seine sogenannte Passivschicht unter dem Einfluss von Sauerstoff selbsttätig neu. Dieser Schutzmechanismus funktioniert allerdings nur solange sich kein Schmutz auf der Oberfläche ablagert. Entsprechende Verunreinigungen sollten Sie daher sofort entfernen, da sie andernfalls seine Passivschicht durchbrechen und Rostflecken bilden können, die nicht mehr zu beseitigen sind. Für die routinemäßige Pflege reicht es, wenn Sie Ihre Leuchte regelmäßig reinigen.

Stainless steel has a unique property: if the surface is damaged, the so-called passive coating heals itself automatically when exposed to oxygen. But this protection mechanism only works as long as no dirt has settled on the surface. Please therefore remove any soiling immediately, as otherwise it can penetrate the passive coating and cause rusty stains that can't be removed later on. For routine care, it is sufficient if you regularly clean the luminaire.

## Legende legend

Lichtrichtung light direction



diffuse



up & down



up/down



down



up



variable



up asymmetric